

RADIO RETAILING
 COMBINED WITH **RADIO TODAY**
 1942

THIS AUDIENCE CAN BE MAINTAINED ONLY IF PRESENT SETS ARE AGGRESSIVELY SERVICED
 57

APRIL

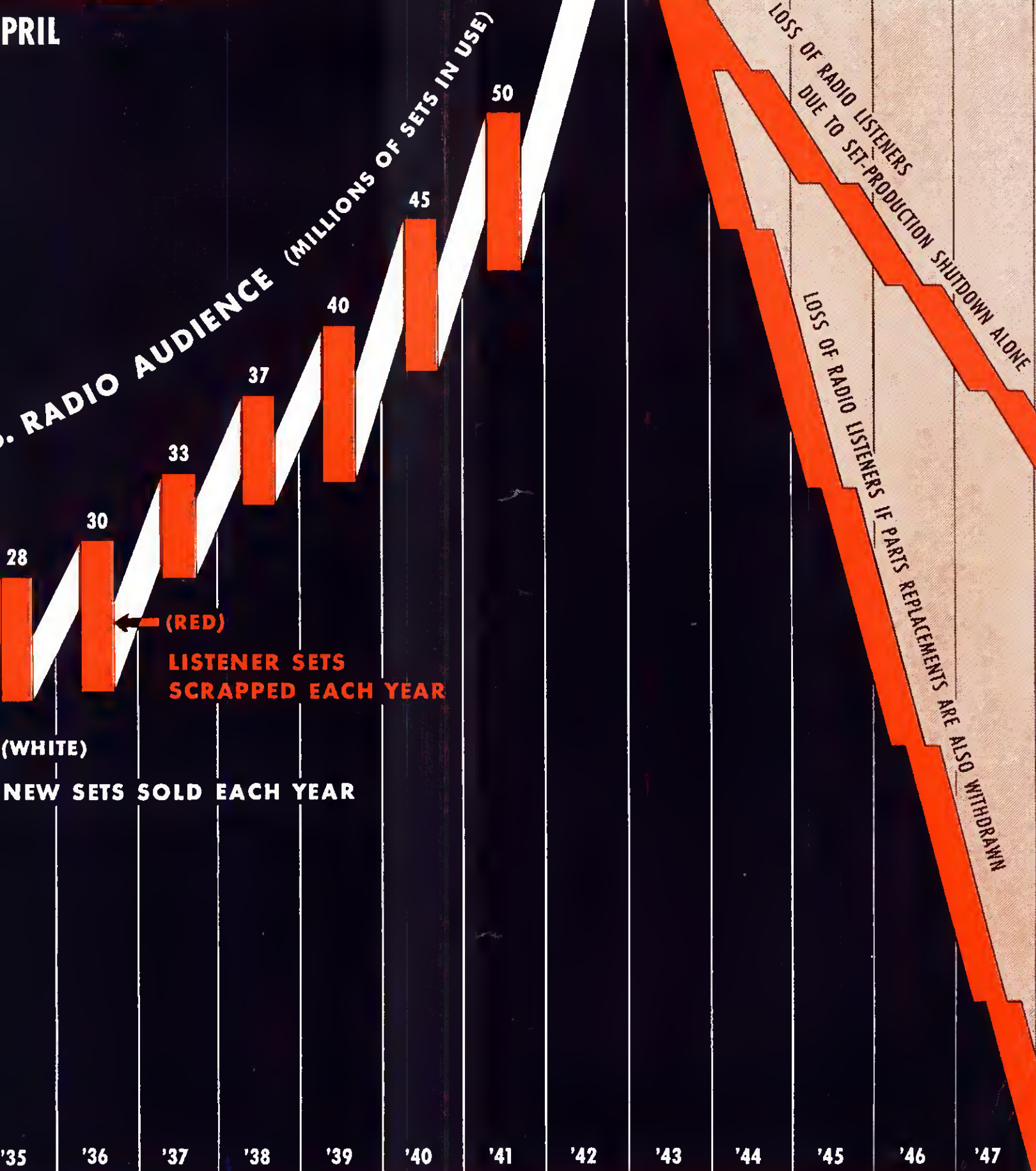

Sold Radio's Instantaneous Link Between the People and the Government —
 REPAIRS ARE A "MUST"



This, Too, Is In The Line Of Duty

The radio service engineer has a home front job. It is not spectacular. It involves more irritations than cheers. But it is all-important, this task of maintaining radio sets in good working order. It calls for knowledge, ingenuity and time-proven, standardized replacement parts.

Mallory appreciates the obstacles of material shortages and production restrictions that confront radio servicemen in wartime. Mallory is playing its role in war production, but Mallory likewise is doing its level best to keep you properly supplied with adequate parts—quality standardized parts—Mallory Approved Precision Products.

And if you're not using Mallory friendly technical help that is yours, free for the asking—you're missing the biggest contribution Mallory has ever made to the radio service fraternity.

Mallory engineers have made mighty strides in adapting parts production to available materials without sacrificing quality. Mallory research is working incessantly to develop new helps, anticipating the future and maintaining the leadership that for years has caused the radio service fraternity to say, "We always can rely on Mallory and Mallory Distributors."

P. R. MALLORY & CO., Inc.
INDIANAPOLIS INDIANA

Cable "Pelmallo"



\$500⁰⁰ FOR AN IDEA

TO HELP YOU STAY IN BUSINESS!

AN OPEN LETTER FROM ROSS D. SIRAGUSA, PRESIDENT, CONTINENTAL RADIO & TELEVISION CORP.

After April 22nd no more radios are to be built. A similar halt has been called in the production of refrigerators, washing machines, vacuum cleaners and other electrical appliances. It's all out for victory!

Existing inventories are adequate to keep most dealers profitably occupied for some months to come. But when these are exhausted, what then? Let's look ahead *now*, and do something about it.

Last year, out of its own funds and entirely without government subsidy . . . the Continental Radio & Television Corp. designed, built and equipped a complete plant which for several months past has been busily engaged in making radio equipment for the Army and Navy. Immediately after April 22nd, our main plant, which is currently building radios and radio phonographs for civilian use, will likewise be converted to war production.

There yet remains a third plant, now making radio cabinets, which has been found impractical to turn over to war purposes. This plant can continue to serve essential civilian requirements. The question is, what to make?

Here is where you can help us . . . and yourself as well. Perhaps you have an idea for a product which we can make . . . and you can sell at a profit. If so, tell us about it. If the idea has merit . . . we, of course, must be the sole judge of that . . . we will take immediate steps to get it into production, and send you a check for \$500 for your trouble.

Bear in mind, of course, that such a product cannot be made of materials essential to the war effort. Obviously, aluminum, chromium, rubber and the like cannot be used. Preferably the item should be made

out of wood or some similar material of which there is an abundant supply.

Your idea does not necessarily have to be something entirely new. An important improvement in a product for which there already is a wide demand will serve equally well. This feature, of course, must be such that it gives the resulting product a decided competitive advantage. After all, *you* must be able to sell it!

One final restriction. Your idea must be for a product that is essential and worthwhile, rather than a mere novelty. It must be something with wide consumer appeal . . . and it must have sufficient merit to justify being branded with our Admiral trade-mark.

Never before has there been greater need for that ingenuity for which we Americans have been justly famous in the past. Those of us who are not directly needed in the war effort can serve our country by supplying essential civilian needs. Think it over, and then let us hear from you as soon as you have something that looks "hot" . . . just the rough idea, we'll work out the details.

CONTINENTAL RADIO & TELEVISION CORP.
3800 CORTLAND STREET CHICAGO, U. S. A.

Manufacturers of

Admiral

RADIOS AND RADIO PHONOGRAPHS

"AMERICA'S SMART SET"



**AGE
BEFORE
DUTY!**

BEFORE Sylvania tubes are pronounced fit for duty, they must prove their merit on a number of tough proving grounds.

In the picture above you see them in the aging rack—where time and the action of a battery of lamps stabilize the electrical characteristics of the finished product.

From the aging rack the tubes pass on to still other tests and processes designed to establish their readiness for service. It's a strait-laced routine that exemplifies the degree of specialized skill Sylvania brings to every step of tube manufacture.

Yet it's only what you would expect of an organization consecrated to one task *and only one* in radio. For all Sylvania resources and energies are directed to the sole end of

providing better, more efficient, longer-lasting tubes.

And because our sales organization is imbued with this same singleness of purpose, the franchise we offer the trade is straightforward, without hedges or loopholes.

Out of this concentration on the one job comes a product whose name is a symbol of excellence, a safeguard of reputation.

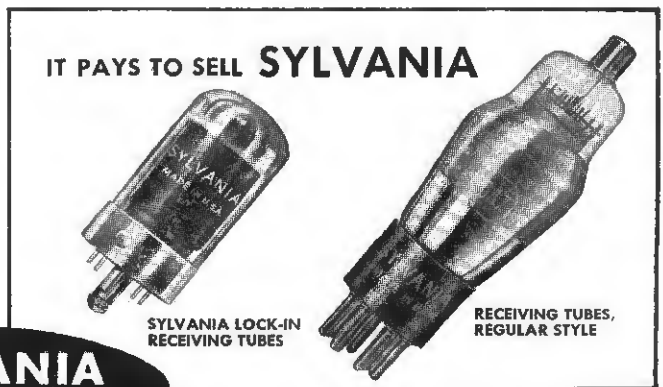

SYLVANIA
RADIO TUBE DIVISION

HYGRADE SYLVANIA CORPORATION

New York City

EMPORIUM, PA.

Salem, Mass.

Also makers of HYGRADE Incandescent Lamps, Fluorescent Lamps and Fixtures.

A Report to RCA Victor Dealers

How a business you helped to build is doing everything to help the all-out war effort...but still hasn't forgotten you!

▶ In these times, particularly, business must realize that it exists because of the people...and that the people are at war. That consideration has greatly altered our business—and *yours*.

▶ Last September, months before Pearl Harbor, we said in a published advertisement: "With RCA Victor, defense comes first. By comparison, we hold nothing else important." To help accomplish our gigantic task, drastic changes in our

production and policy have been made. Naturally, these changes have affected you; and we are grateful for the spirit of cooperation you have shown. For your sacrifice of RCA Victor equipment has made possible extra production of *military* devices; and this, we hope, means commercial production sooner than if we had procrastinated and not done what we felt was our patriotic duty. (We finished our last radio at Camden 50 days *before* the deadline set by the Government.

▶ When this war is over, you'll be more glad than ever to be an RCA Victor dealer! For great things are ahead—new RCA Victor products, to make your business bigger and more profitable than ever. Meanwhile, we have not forgotten that it is part of our job to help our dealers through the war period in every possible way. Right now we are testing out several ideas that will not interfere with the country's war effort but should produce business for you.



Questions and Answers About RCA Victor's "All-Out" War Production



In what ways has RCA Victor been engaged in war production?

In every way that our facilities permit. Plant formerly manufacturing radios and phonograph-radios is now making radio equipment for war purposes. RCA Laboratories have placed their vast resources at the disposal of the Government. The RCA Electron Microscope is inspecting materials for war equip-

ment with accuracy and speed. RCA chemists and physicists are developing alternate materials to take the place of those whose supply is limited.

What progress has RCA Victor made?

RCA Victor is today turning out an enormous volume of equip-

ment for America-at-war. This has been made possible by RCA Victor's famous "Beat the Promise" campaign symbolized by the letter "E" and the code "...", and by the huge facilities and equipment built up through your sales of radios in time of peace and made available by your foregoing this business in time of war. As a result of our war efforts RCA Victor has been awarded the Navy "E" flag.



RCA VICTOR

RCA MANUFACTURING COMPANY, INC., CAMDEN, NEW JERSEY

Pledge

**TRIPLETT MEN AND WOMEN
HAVE SIGNED THIS PLEDGE TO
AMERICA'S VICTORY**

The Nation needs us strong —

I WILL KEEP FIT!

Lost hours help our enemies.

My working time is America's time —

I WILL TAKE NO "TIME-OFF"!

Carelessness causes accidents.

Accidents annually cost enough man-hours to build 15,000 bombers —

I WILL BE CAREFUL!

Some American soldier may die if indifference to the
importance of small jobs results in poor work —

I WILL KEEP MY INTEREST!

The future welfare of America will rest upon the increased
knowledge which will emerge from present necessity —

I WILL ADVANCE!

These things *I PLEDGE* that our future
may be secure for Life, Work and Service.

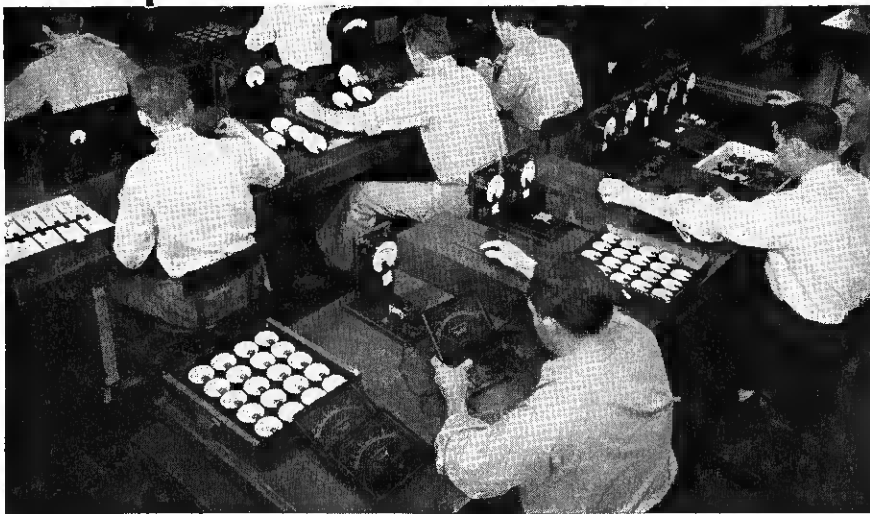

Accuracy—as Ever

Despite the rush of present production there is no relaxation from rigid requirements of accuracy in calibration and inspection of fine Triplett instruments. No compromise is permitted to affect in the slightest those exacting standards which have become the international Hallmark for precision and quality.

TRIPLETT ELECTRICAL INSTRUMENT COMPANY

BLUFFTON, OHIO

Centralab

The Quality Line

STANDARD RESISTORS
Resistors are the backbone of every electronic circuit. Centralab's standard resistors are available in a wide variety of values and wattages. They are made from high quality materials and are guaranteed to meet or exceed the industry standard.

WIRE WOUND RESISTORS
These resistors are designed for high power applications. They are made from a special alloy and are capable of dissipating large amounts of heat without becoming distorted.

AXIAL LEAD RESISTORS
These resistors are designed for use in electronic equipment. They have long leads and are easy to install and remove.

SEND FOR CATALOG NO. 23

For Every Need in EVERY Emergency

Centralab AXIAL LEAD RESISTORS

Under modern conditions, the old man's "Little" resistor is the "every" "small" resistor. It is the resistor that is most likely to be needed in an emergency. It is the resistor that is most likely to be found in a kit. It is the resistor that is most likely to be used in a circuit. It is the resistor that is most likely to be the "right" resistor.

CENTRALAB Div. of Globe-Union Inc., Milwaukee, Wis.

Complete NET only \$10.95

Always THE RIGHT REPLACEMENT CONTROL WITH THIS CENTRALAB PORTABLE

Wardcraft Kit

Centralab

Answering the Call

A—STANDARD
Ready for use in the laboratory or in the field. It is the resistor that is most likely to be needed in an emergency.

B—MIDGET
Small in size, but large in capability. It is the resistor that is most likely to be found in a kit.

C—ELF
Small in size, but large in capability. It is the resistor that is most likely to be used in a circuit.

CENTRALAB Division of Globe-Union Inc., Milwaukee, Wis.

Centralab RADIOHMS

A **B** **C**

Plotting the Curves of Progress

Old Man Centralab is not only an old-timer, but he has a modern mind. He is the man who knows what you need, and he is the man who can give you what you need. He is the man who can help you solve your problems, and he is the man who can help you make your progress.

CENTRALAB Division of Globe-Union Inc., Milwaukee, Wis.

We view with pride... Old Man Centralab

In his humorous way, Old Man Centralab has been telling you about Centralab products for so many years that he seems an actual person. We are proud of that fact... proud too, to say that while Old Man Centralab's products are needed now on many fronts, we are still pledged to serve you.

At your jobbers—you may still "SPECIFY CENTRALAB" with assurance that the Old Man is there to serve you.

Centralab

Div. of Globe-Union Inc., Milwaukee, Wis.

CONTROLS • SWITCHES RESISTORS CAPACITORS

There's a SW...

CENTRALAB SWITCHES WITH BRASSITE INSULATION
These switches are designed for use in electronic equipment. They have long leads and are easy to install and remove.

CENTRALAB SWITCHES WITH MELTITE INSULATION
These switches are designed for use in electronic equipment. They have long leads and are easy to install and remove.

Still promise... QUALITY!

STILL promise... QUALITY!

At your jobbers—you may still "SPECIFY CENTRALAB" with assurance that the Old Man is there to serve you.

CENTRALAB Division of Globe-Union Inc., Milwaukee, Wis.

Radio Amateurs!
Radio Servicemen!
Radio Engineers!

Be a **RADAR** Specialist with the United States Navy . .

Here is your opportunity to serve your country and advance yourself at the same time. The U. S. Navy needs 5,000 picked men to install, operate, maintain and repair RADAR equipment—the secret ultra high frequency apparatus used to locate airplanes. If you are an Amateur, Serviceman or Engineer YOU may be eligible.

*You go into the Navy as a Petty Officer with food, quarters, uniforms, medical and dental care supplied *plus* pay of from \$60.00 to \$106.00 monthly. After the*

successful completion of eight months technical training you are eligible to immediate promotion to the rank of Chief Radioman with pay up to \$175.00 monthly the first year and up to \$200.00 per month thereafter—with opportunities to remain in the service permanently.

Go to your nearest Navy Recruiting Station TODAY (generally in your local post office) and find out how YOU can take advantage of your technical knowledge. THE NAVY NEEDS YOU!



UNITED STATES NAVY
Ask at Your Local Post Office

OUT IN *Front*

with

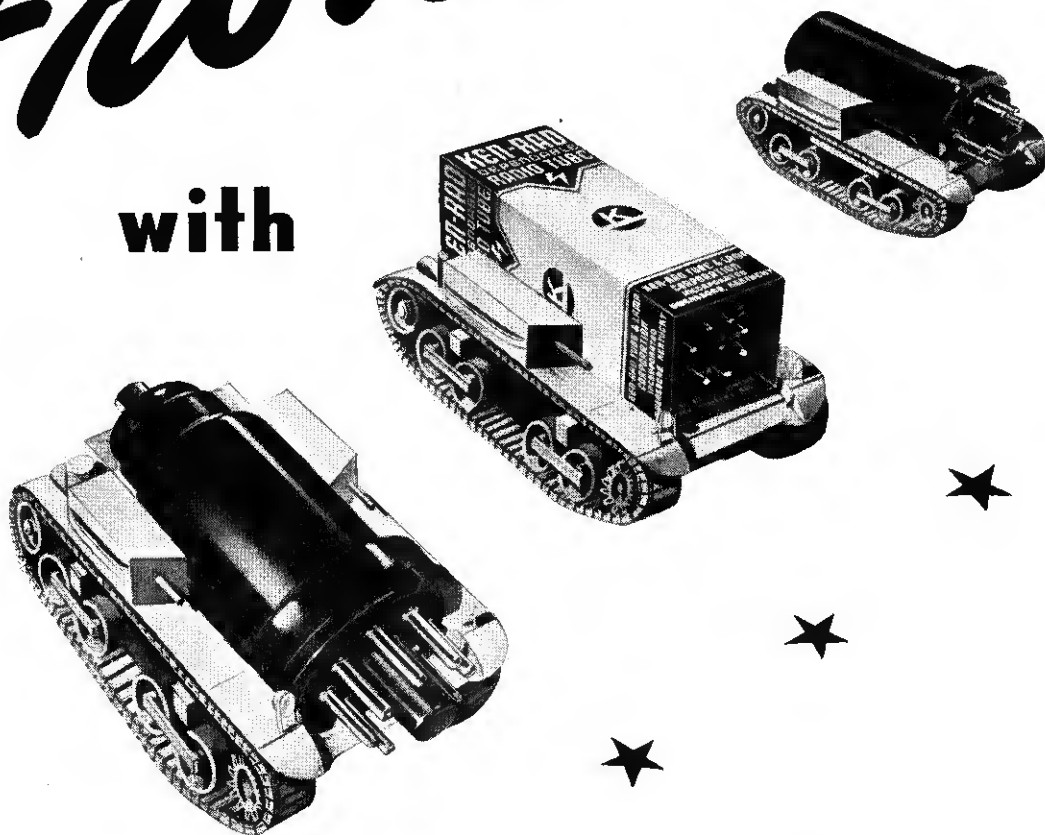

★ METAL TUBES

Yes, radios with metal tubes are out in front in performance. That's why we make and recommend them. That's why 80,000,000 are now in use.

Handle Ken-Rad Metal Tubes and Be Sure of Satisfied Customers.



KEN-RAD

Metal Radio Tubes



KEN-RAD TUBE & LAMP CORPORATION, Owensboro, Kentucky



A WAR MESSAGE

to

ALL EMPLOYERS

★ From the United States Treasury Department ★

WINNING THIS WAR is going to take the mightiest effort America has ever made—in men, in materials, and in money! Every dollar, every dime that is not urgently needed for the civilian necessities of food, clothing, and shelter, must, if we are to secure final Victory, be put into the war effort.

An important part of the billions required to produce the planes, tanks, ships, and guns our Army and Navy need must come from the sale of Defense Bonds. Only by regular, week by week, pay-day by pay-day investment of the American people can this be done.

This is the American way to win. This is the way to preserve our democratic way of life.

Facing these facts, your Government needs, urgently, your cooperation with your employees in *immediately* enrolling them in a

PAY-ROLL SAVINGS PLAN

The Pay-Roll Savings Plan is simple and efficient. It provides, simply, for regular purchases by your employees of United States Defense Bonds through systematic—yet voluntary—pay-roll allotments. All you do is hold the total funds collected from these pay-roll allotments in a separate account and deliver a Defense Bond to the employee each time his allotments accumulate to an amount sufficient to purchase a Bond.

The Pay-Roll Savings Plan has the approval of the American Federation of Labor, the Congress for Industrial Organization, and the Railroad Brotherhoods. It is now in effect in several thousand companies varying in number of employees from 3 to over 10,000.

In sending the coupon below, you are under no obligation, other than your own interest in the future of your country, to install the Plan after you have given it your

consideration. You will receive—1, a booklet describing how the Plan works; 2, samples of free literature furnished to companies installing the Plan; 3, a sample employee Pay-Roll Savings authorization card; and 4, the name of your State Defense Bond administrator who can supply experienced aid in setting up the Plan.

To get full facts, send the coupon below—today! Or write, Treasury Department, Section B, 709 Twelfth St., NW., Washington, D. C.

HOW THE PAY-ROLL SAVINGS PLAN HELPS YOUR COUNTRY

- 1 It provides immediate cash now to produce the finest, deadliest fighting equipment an Army and Navy ever needed to win.
- 2 It gives every American wage earner the opportunity for financial participation in National Defense.
- 3 By storing up wages, it will reduce the current demand for consumer goods while they are scarce, thus retarding inflation.
- 4 It reduces the percentage of Defense financing that must be placed with banks, thus putting our emergency financing on a sounder basis.
- 5 It builds a reserve buying power for the post-war purchase of civilian goods to keep our factories running after the war.

It helps your employees provide for their future.

MAIL THIS COUPON NOW

Treasury Department, Section B
709-12th St., NW.
Washington, D. C.

We want to do our part. Please
rush full information regarding
the Pay-Roll Savings Plan.

NAME

POSITION

COMPANY NAME

ADDRESS

NUMBER OF EMPLOYEES



MAKE EVERY PAY-DAY... BOND DAY!
U. S. Defense BONDS ★ STAMPS

This space is a contribution to NATIONAL DEFENSE by RADIO RETAILING—TODAY

GPO 16-25943-1 Form No. DSS-BP-2





**RAYTHEONS PROVE
THEIR STAMINA
ON THE NAVY'S NEW PT BOATS**

Bouncing over the waves at nearly a mile a minute our new PT boats are the fastest fighting craft afloat today. This breath-taking speed takes its toll of both men and equipment . . . RAYTHEONS prove their stamina by being able to function under this grueling test. The crew of a PT boat are selected with extreme care . . . they must be physically fit to stand up under the strain of constantly pounding the water, sudden turns and cramped quarters. RAYTHEONS too must take this punishment and deliver peak performance . . . the same dependable performance they have been giving to servicemen everywhere.

Successful servicemen and dealers realize the advantage of RAYTHEON replacement tubes to protect their profits, turnover and the goodwill they have built up in their communities. With all their plus advantages, RAYTHEONS cost no more . . . Insist on RAYTHEONS for your next tube order.

Raytheon Production Corporation — New York, Chicago, Los Angeles, Atlanta, Newton, Mass.

NOTICE! If you have not obtained RAYTHEON'S interchangeable Tube Chart, it is important to get one of those cards at once from your RAYTHEON jobber. Speeds up radio repair service and simplifies your tube stock by elimination of a large number of types.



**RAYTHEON
RADIO TUBES**

WORLD'S LARGEST EXCLUSIVE RADIO TUBE MANUFACTURER
RADIO RETAILING Combined with RADIO TODAY, April, 1942

“How I have prepared today for the radio market of tomorrow!”

J. C. HOLTBY, RADIO DEALER, OF LANSDOWNE, PA., GIVES A TIMELY TIP ON HOW TO BEAT THE SHORTAGE...

J. C. HOLTBY is an authorized Stromberg-Carlson dealer who knows the value of personal contact. Says he: “People appreciate it when you show that you are interested in giving them the best performance that the manufacturer has put into their set. We find that this kind of service builds customer loyalty.”



“WHEN the papers flashed the word that soon no more radios could be manufactured, I went into action . . .

“First, I studied my sales for the past few years and got a breakdown on the different types of chassis our community has been buying. With this breakdown I have tried to anticipate our repair needs and have put in more parts stock than usual to take care of the added demand and to speed up service.

“Next I started running small advertising copy in our local paper. And since I want my store to be known as the best place in Lansdowne for radio service and repair, I use the slogan, *“A business built on personal service to the community.”*

“I have also called all customers who have bought Stromberg-Carlsons recently, and reminded them to send in their

warranty cards. And I have invited them to stop in any time for additional information about their set. Some of these customers gave me names of friends who might be prospects for radio service.

“To these people and other prospects I send postal mailing pieces from time to time, with a postage-paid return card attached. These pieces suggest specific service which should periodically be done on any radio, and have pulled good returns.

“Our repair business has grown because we take a personal interest in the customer’s trouble. And our best asset is word-of-mouth advertising. I find that when you are interested in the quality of your repair work and are sincere and doing your best, the volume takes care of itself.”

IN RADIOS, TELEPHONES, SOUND SYSTEMS
... THERE IS NOTHING FINER THAN A

STROMBERG-CARLSON

ROCHESTER,
NEW YORK



“SINCE THE SHORTAGE of radio has developed,” declares Mr. Holtby, “we have made an extra effort to keep a neater shop so that the customers who come in the store for other reasons can get a full view of our facilities.” Good display of available merchandise is more important than ever. So, too, is the emphasis on sales of records. Holtby Radio’s record selection is large and well-assorted.

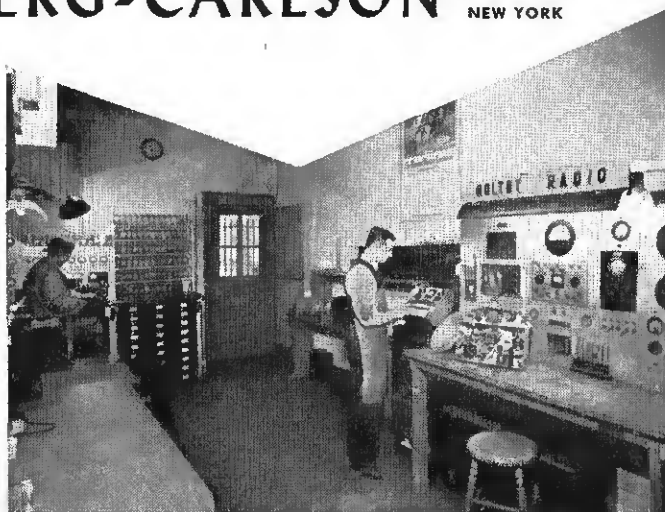

GOOD TESTING EQUIPMENT is a first “must” for a successful radio repair business. As this picture shows, Mr. Holtby’s shop is well equipped. “We always carry a good stock of repair parts,” he says, “in an effort to speed up service, as I find most everyone wants their radio at once.” He also takes advantage of Stromberg-Carlson’s 24-hour service on genuine factory parts, to keep his repair orders moving out on time.

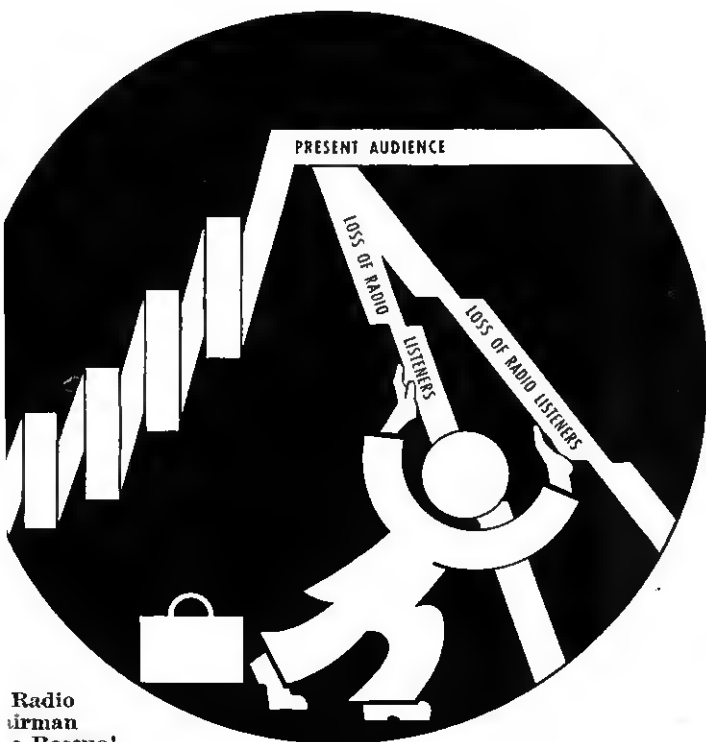

Radio
man
e Rescue!

RADIO RETAILING COMBINED WITH RADIO TODAY

O. H. CALDWELL, EDITOR. M. CLEMENTS, PUBLISHER
480 LEXINGTON AVE., NEW YORK, N. Y.

do their former regular servicing, or more! And in addition, they must *put back into operation* the millions of sets which normally would have been dropped from use.

Shutdown of radio-set production, taken alone, will deplete the radio audience by 4 to 6 million sets per year, as the cover chart shows, by one descending line.

And if radio repair parts are also shutdown and necessary repair material is withdrawn from trade channels, servicemen will be prevented from carrying on even their *normal* repair work. And then the rate of radio audience decay will be accelerated by another 4 to 6 million sets "going dead" per year, making the broadcasters' audience crumble at the rate of 8 to 12 million sets per year.

Such a double-barrelled catastrophe we hope will never come to pass, even in all-out war!

Neither of these blows to U.S. listening and U.S. morale need happen, if radio repairmen can get the repair parts they need.

To Keep U.S. Radios Working:

(See charts, front cover, and page 17)

If the supply of babies were suddenly cut off,—the nation's future population curve could be accurately forecast,—simply by knowing the former adult death-rate.

Something like this has happened in radio!

With new-set production halted April 22, it will become a simple operation to figure, from the past mortality of radio sets, what the mortality will be among the existing 57 million radios—in a future *without* new sets pouring off the factory lines. The resulting alternatives are traced on the front cover of this issue.

Six Million Sets "Pass Out" Each Year

In recent years we have sold 10 to 13 million radio sets per year, right in the U.S.A. Yet the total sets *in use* at the end of any such year, increased by only 6 to 7 millions for that year. (RMA and NAB statistics confirm these figures.) So it is evident that 4 to 6 million set have annually been "scrapped" or dropped from use, because inoperative or obsolete,—and never restored to working condition.

Now that new sets are no more, the former rate of mortality will still continue, of course, each year. And will continue to *deplete* existing sets at a rate of 4 to 6 million sets per year. As a result, the radio audience seems bound to shrink by millions of sets annually,—*unless* radio repairmen aggressively maintain every one of these sets in operating condition.

To do this, of course, will throw a double servicing load on the radio service men of the nation. For they must

Unless Servicing Doubles, Audience Dwindles

The radio audience *can* be maintained at its present level of 57 million sets. But the amount of servicing required in '42 and '43 will *not* be *merely* at the rate of repairs, replacements and renewals of last year—'41.

To hold 57 million sets in use, will take *double* the servicing, *double* the tube replacements, *double* the repair parts of any recent *normal* year, when new sets were providing at last 50 per cent of the replenishments making up the inexorable mortality in radio receivers.

To furnish the necessary repair parts, only a few million dollars' worth of raw materials are required annually. (Compare this modest requirement to keep the radio audience intact, with the billion dollars of paper used annually by newspapers and magazines, and regarding which there has been no thought of curtailment.)

A 250-to-1 Saving

Looked at another way,—to supply print paper for America's newspaper and magazine readers, requires the use of about 500,000 freight-cars annually. Whereas to maintain the radio audience at 57 million sets, will require only about 2000 car-loads of materials,—a saving of 250-to-1 in carrier-line tie-up and in coal.

Radio is performing a priceless patriotic service for the nation and the Government. To keep this great instrument of public morale in full operating effectiveness,—to hold radio's instantaneous link between the people and the government—

Adequate repair parts and radio repairs are a **MUST!**

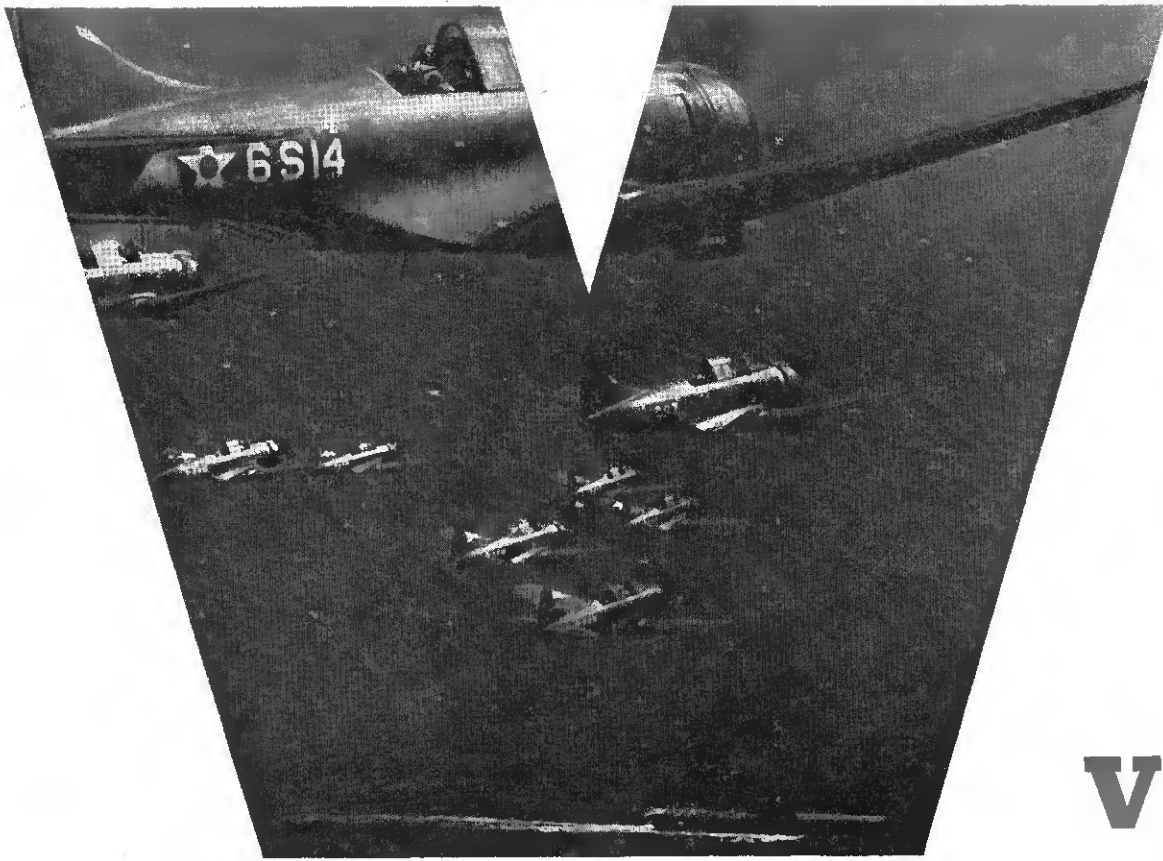

At the left is illustrated the ship-to-plane communication by radio, in an official U.S. Navy

At the immediate right is a radio code-free instruction wartime by new Women's League of America.

At extreme right is the singer Frances Langford Hope's show on NBC, a favorite Army Camp appearances.

VICTORY



In the three dots before the dash at the right are glimpses of Philco workers in a giant war production rally, Phila.



Four soldiers of the Signal Corps, Ft. Monmouth, N. J., all of them recruited from radio, prepare a soldier-talent television show for NBC.

Radio's famous Quiz Kids get a medal from Father's Day Committee. Father is honored this year June 21, as "Defender of the



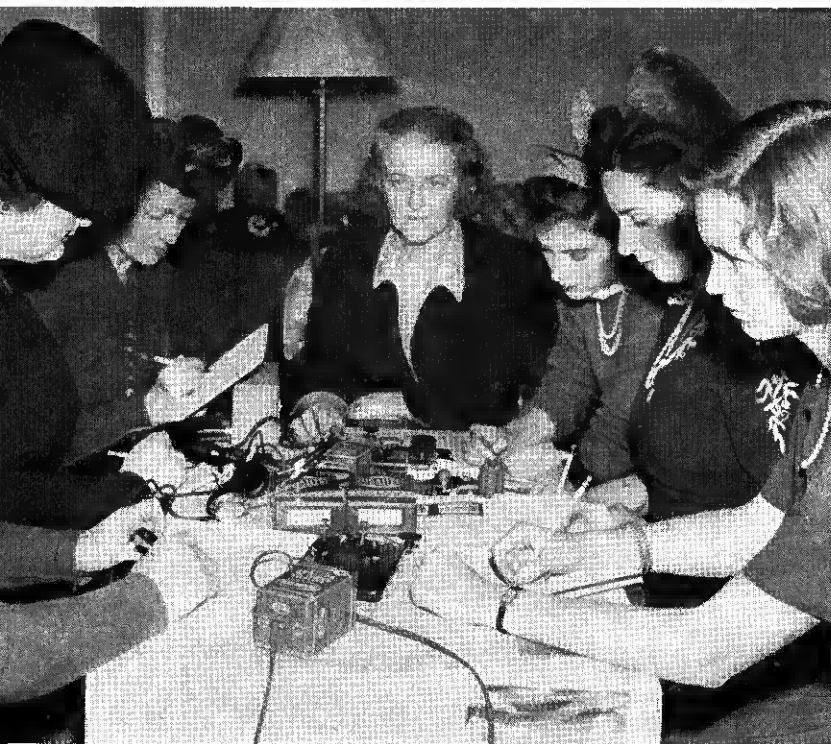

JOBS FOR RADIO

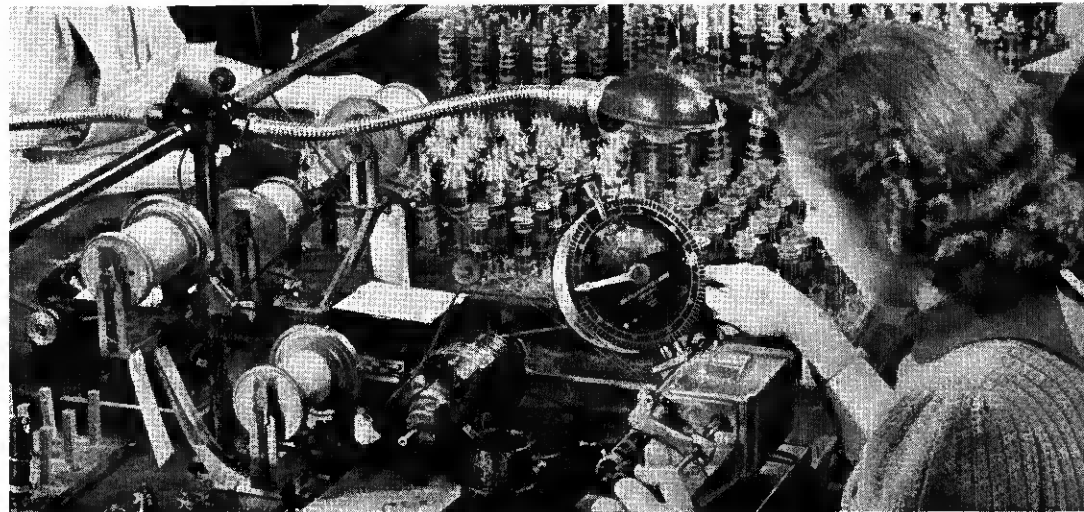

Skilled women, like this radio coil winder at Zenith, are important in war production.

Thousands of new secretaries in war industries are being trained by this Microphone, Western Electric magnetic tape recording device.

Better antennas help to get all the war news. Here Crosley's Kraut-ter and Rasmussen examine company's new Signal Web antenna.



NEW HORIZON



SERVICE REPAIRS RECORD CABINETS AIR-RAID ALARMS SOUND JOBS B

• In the two decades since broadcasting began, the radio industry has been confronted by many and diverse problems. Few of them have come more abruptly, or present greater potentialities for far-reaching results than the wartime problem of radio-dealers.

The raw materials and the productive capacity of the radio industry are sorely needed to provide the staggering quantities of military radio equipment needed to prosecute this war.

And so, it is fitting and proper that the production of radio for purely entertainment purposes should be stopped, as it has been.

There are ample stocks on hand to

last for a number of months. Between now and then the radio dealer has a job—a big job—to do.

Problems to Face

Certain facts seem to stand out.

Radio sales are certainly not going to be maintained much longer. Expenses must be put under definite control, and should also be reduced wherever possible.

Unnecessary improvements in store fixtures, front, should certainly be avoided.

Cash must be conserved.

Personnel must be kept under constant observation, sales, office, stock, service, and where they do not render

a full measure of return, they must be replaced, or displaced. Personnel will also have to double up wherever possible, work longer and harder, do more than they have ever done before.

But no amount of reduction of outgo can save a business which has lost its income.

By far the larger problem is to maintain income, keep sales up. How can that be done?

Sell Service

General MacArthur says "We will win—or we will die."

Radio dealers will solve the problem, but it will call for every bit of your ingenuity and enterprise, and courage, today and every day.

You must be constantly alert for every opportunity, with minds open and working fast.

The first place to give your sales promotional attention is your service department. By every means at your command, you must sell the service department, and the need for it. Merchandise your service department, with as much ingenuity and as much

Some 18 radio jobbers throughout the U. S. have already been franchised to supply dealers with these colorful and modern "Nesting" chairs—a trend to furniture while radio lines are short. They make sectional sofa, complete divan, or nest into a single chair; they're made by Edelmuth Co., 1010 Euclid Ave., Cleveland.



FOR RADIO DEALERS

ES ELECTRONIC DEVICES

SPECIAL FURNITURE

KITCHEN FURNITURE

PAINTS

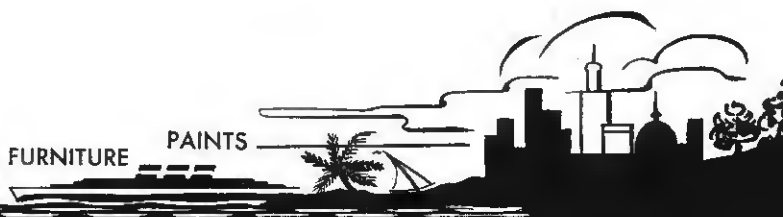

nerve as you ever used in the "good old days" to sell your radio.

And remember there's a lot of service business besides radio-service which you can do, if you are ingenious enough.

The idea of one radio-appliance dealer, who took on the plumbing work in his little community when the plumber joined the colors, can be amplified and adopted in any community.

Radio dealers who do this work will not only be maintaining their income, but will be making friends, too, against the day when radio can be sold and will be.

Diversification or Consolidation

Certainly you will also canvass the sales possibilities of sound, for industrial applications and defense uses. You will look into the very large sales and maintenance field of electronic safety and production devices and controls, now finding ever-increasing applications in industry. You will seek out new merchandise which may not be related to radio, which you can sell to your customers and keep your business a "going" business. This is not just a problem of buying what you can buy, and then trying to sell it. Selecting new merchandise should be based upon your local conditions and needs.

In many cases an actual consolidation or merger of two or more businesses to share fixed expense among them, will serve the same purpose for all concerned.

Where this cannot be done, certain important factors should be given full and careful consideration, before new lines are taken on.

Has your community had distribution of the production in question equal to the demand? Does it still

have adequate distribution? Just where will you fit into the picture and why?

If you enter into free competition with lines which already have distribution equal to demand you will be solving no problem, will in fact, be creating another one.

Weigh your reasons for taking on a new line of merchandise carefully and well before you go ahead and know what you will do and how, before you start.

You must maintain turnover, and keep your position liquid. Stocks must be kept well in hand and moving. Margin must be maintained. Cash and working capital must be built up and preserved.

Keep "On Your Toes"

Equally as important is keeping your viewpoint and your mind open and ready for action.

Look for every possibility of doing business. Investigate and try other ways of doing business. And when

you see, or think of, something which has promise, try it.

Where, in the past you have looked upon other lines as "side-lines," soon you must look upon radio sales as a side line.

And if you see the picture clearly enough you will make more money in the future than you have in the past.

For few lines have been so obsessed with cut-prices, discounts, false advertising and long trade-in allowances to eat up profits as have radio and refrigerators.

It all boils down to how clearly you think, how surely you act, how carefully you plan, how accurately you control—your new ventures.

Merchants there are among us who will go on to bigger and better business in spite of the handicaps and the hardships of the present situation.

Just as you saw the future of radio—ten, fifteen or twenty years ago, so now you must canvass music, sporting goods, furniture, anything, to keep you going pending the return of radio.

Though facing 70% cut in volume, records are one of dealer's best bets. This window, at Boston Music Co. gets extra interest by tracing recording history.





A war-production scoreboard at RCA Victor plant has seized the attention of radio's "beat the promise" workers.

RADIO GOES 'ALL OUT'

• Dealers will probably have plenty of home radio sets until well after the opening of the coming fall season. But following that, it is anybody's guess how long existing stocks will supply the winter demand.

Some high officials in Washington predict that 15 months' or a year's supply of home receivers will be on hand—in manufacturers', distributors' and dealers' stocks—by the time production is shut off. But industry leaders question how the four million sets, which it will be possible to complete during 1942, will go very far in supplying a market which, after having absorbed 13 million sets in 1941, is increasing rather than diminishing in buying power.

The date set by Washington for the shut-down of radio-set manufacture—April 22—still stands. But seven home-receiver makers have already been given extensions which will carry them well into June, and it seems possible that other extensions may be granted before final cessation of work.

"Victory" and Latin-American Sets Out

Efforts to set up a special schedule for the production of "Victory Models" which, it was hoped, would load up home-receiver manufacturers not able to convert to full war output, have now been abandoned after the

project was frowned upon by the War Production Board. It now seems likely that no further attempt will be made to manufacture these simplified small radios, which were to have been produced in factories not suitable for war contracts, and to be marketed under various familiar trade names through existing trade channels as a means of at least providing a trickle of new merchandise for distributors and dealers.

Rules Tightened

Also tossed into the WPB wastebasket was the Rockefeller Committee's proposal that the U. S. radio industry build 300,000 to a million small all-wave sets for South America. The plan here was to provide combination broadcast and short-wave receivers, which would enable Latin-American listeners to pick up both their local broadcast stations and also short-wave programs being beamed from the United States. These sets were to have been sold at a low unit price. Their manufacture was counted on to fill in the interim period for many U. S. set makers, between shut-down of regular domestic lines and plant conversion to full war production. But here again the War Production Board ruled against using materials or the time of workers for any-

thing except all-out war production, and so the South American set also went overboard.

OPA Freezes Prices

With enough home radios on hand for the American market, the Office of Price Administration has not seen fit to ration radio receivers, as it has already done with other durable-goods products. From trade stocks and unused "attic sets" enough radios will be available, it is believed, to supply needs of domestic listeners for a long time to come. No rationing is contemplated in the home-receiver field.

On March 30, however, prices of home receivers and automobile sets were frozen for 60 days, at the levels obtaining as of March 19. As a step in carrying out this order, each store is required to post publicly the prices at which sets were offered prior to the freezing date. Penalties for infractions of this or any other OPA order may involve licensing or closing of any store or outlet.

Such price schedules apply to each individual store, and when different price policies have been maintained in stores in different localities but under the same ownership, the stores must be treated as individual operations, and each is required to observe its own former current prices without respect



Ready to step into their new Victory jobs are these hundreds of Crosley employees, greeting a government spokesman.

OR WAR

to prices maintained at other premises operated by the same owners.

Tube Situation

Authority had previously been given for producing 27 million replacement radio tubes, but during the last 30 days, completion of this quota seemed questionable because of the shortage of necessary mica. This mica bottleneck now seems in way of being solved through heavy stained mica substitutes and through commercial sale of "rejects" of military tubes.

Meanwhile an elaborate plan of rationing and exchange of burned-out tubes has been developed for use if necessary. Under this plan—now postponed, but a possibility later—each

retail purchaser of a radio tube would be required to turn in to the dealer a tube or base of the same type which the purchased tube replaced. Dealers however would be required to turn in to distributors *not* identical tubes but *any types* to the same number of total tubes. Dealers would also be required to accompany their old tubes or bases with the cartons of the new tubes they had just sold. This requirement of turning in empty cartons would afford a check on the new tubes being sold to the public. The

(Continued on page 41)

THE INDUSTRY'S YEAR-BY-YEAR SALES OF NEW RADIOS TAKES A NOSE-DIVE IN 1942, AS THE WAR PRODUCTION BOARD TAKES OVER. COMPARED WITH 1941, THE COLUMN FOR THE PRESENT YEAR PLACES DRAMATIC EMPHASIS ON THE NEED FOR REPLACEMENT PARTS FOR SETS ALREADY IN USE.



100 MILLION RADIOS SOLD SINCE 1920

57 MILLION RADIOS NOW IN USE IN U. S. HOMES

Priorities on Parts

Jobbers Make Bid for Wartime Supply of Vital Replacements

The vigorous efforts of the National Radio Parts Distributors Association to facilitate the wartime flow of radio parts are continuing on a big scale, according to a report by the NRPDA president, George D. Barbey of Reading, Pa.

It is pointed out in the statement that so far "we do not have a priority on parts . . . only a gentleman's agreement to keep home sets operating." In this situation, the issue of the new priority form PD-IX is cited as "the best news for the parts jobber since priorities became a problem."

When the War Production board announced the issue of PD-IX for distributors, it listed 16 different types of supplies as being affected. "Electrical" supplies were included, and Mr. Barbey reports that he obtained a ruling in Washington that this would definitely include radio supplies.

Special for Jobbers

WPB explained that "priority problems of distributors will be simplified by the use of the new application form designed for their special use . . . insofar as materials and supplies can be

made available without interfering with the war effort, priority assistance will be given to distributors who apply on the new form so that they can keep sufficient stocks on hand to maintain essential productive and service organizations in operation." The new form enables distributors to request preference ratings for essential supplies without receiving or extending a rating on every individual order which they fill.

Things to Watch

Distributors using PD-IX will be required to furnish information on their sales and inventory of the types of material concerned. They will also be required to show the percentage of material shipped out of stock on rated orders during the preceding month or second preceding month, as compared with total sales if such information is available. Other information is also required by WPB.

Following his study of the general situation in radio parts supplies, and his contact with government officials in charge, the NRPDA president has made the following comments:

"Jobbers should make no 'promotions' or concessions to encourage large buying. Materials for radio parts are scarce and getting scarcer.

"Distributors may encourage dealers to carry a 30-60 day supply of standard parts but no hoarding should be tolerated.

"Hoarding by jobbers, dealers, or consumers, always results in rationing. This will happen in radio parts, as in other commodities, if over-buying continues. If you do not wish rationing, with its accompanying headaches, see that you *buy and sell sensibly*.

Question of Survival

"It is quite probable (a) That every dealer will be required to sign, on every order, a statement similar to the one you signed for your condenser manufacturer, 'that this material will be used only to replace defective parts in an existing set. (B) That it will be required that a defective part be turned in to get a new one—not so much for salvage as to prove disposition of the new part. (C) That there will be a limitation of repairs when there is more than one set operating in a house.

"The wire situation is bad (rubber and copper). There is some doubt as to whether even the new PD-IX will help on wire, for it took an A-1-A to get certain types of wire during the past month.

"Some solder will be available but the tin content will be reduced to 30 per cent. Soldering irons were classified as electrical appliances, and therefore scheduled to go out of production April 22. The electrical industry is working on this.

"THERE ARE STILL NO PLANS to take care of distributors and retailers who have been, or will be, deprived of merchandise. A word to the wise should be sufficient. Donald Nelson said that part of our fight is to preserve free enterprise. 'Free enterprise' consists of two words—one of them is *ENTERPRISE*."

Here's a typical source of supply for the increasingly vital radio replacement parts—the shipping dept. of Radio Supply Co., distributor of Norfolk, Va.



RECORDIO

Wilcox-Gay's Peacetime Products
Still Serve on the Home Front—



While Wilcox-Gay's Wartime Products
Now Serve on Farflung Battle Fronts

WILCOX-GAY CORPORATION

Accepted Leaders in the Home Recording Field

CHARLOTTE, MICHIGAN

New Products

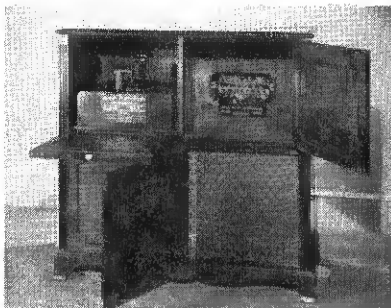

S-C "WILFRED PELLETIER" No. 1035-PLW radio-phono model features 4 tuning ranges in walnut Hepplewhite cabinet. One set of 8 push buttons for both AM & FM. Automatic range shift, full floating labyrinth & carpinchoe speaker. Pull out phonograph drawer. Automatic record changer plays 10 or 12 in. records. Also available in mahogany. Stromberg-Carlson Tel. Mfg. Co., 100 Carlson Rd., Rochester, N. Y.—RRT

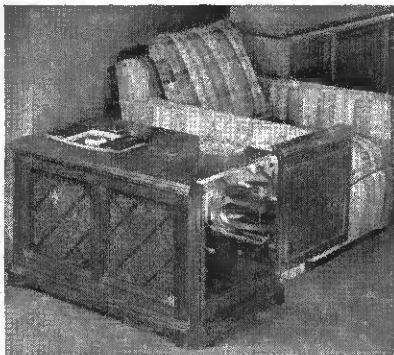

ZENITH CHAIRSIDE RADIO, The Chatham, 12H691, provides frequency modulation, standard and shortwave reception plus the automatic playing and changing of phono records. Housed in a mahogany cabinet. By pushing a button the playing mechanism slides out automatically from the cabinet. Genuine Armstrong FM. Radiorgan tone mixing. Zenith Wavemagnet built-in aerial. Zenith Radio Corp., 6001 Dickens Ave., Chicago, Ill.—RRT.

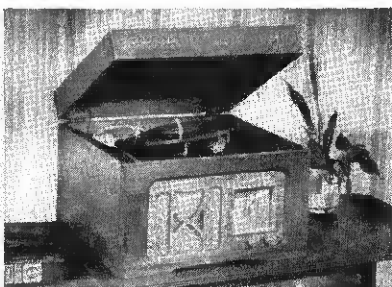

SONORA 5-TUBE AC automatic phono-radio plays twelve 10 in. or ten 12 in. records. Superhet radio tunes 535-1720 kc. "Sonorascope" loop, dynamic speaker, A.V.C. Walnut veneer cabinet with carved-effect hinged lid. Sonora Radio & Telev. Corp., 325 N. Hayne Ave., Chicago, Ill.—RRT.

CROSLLEY 1943 RADIO LINE—six new radio receivers have been announced featuring the new Signal Web antenna. Four are combination radio-phonograph consoles, one is a console radio receiver and the sixth is a 2-band table farm set. Two of the combination sets are 10-tube AC superhets with 3 complete bands, Master Tone control. All the combos have the floating jewel tone system with permanent stylus. Crosley Corp., 1329 Arlington St., Cincinnati, Ohio—RRT



PHILCO PHOTO-ELECTRIC radio-phonograph, 1011, has 10 tubes. Automatic record changer, variable speed phono motor. Tilt-front cabinet with interior light. Built-in aerial system. Electric push-button operation, 10 buttons. Concert Grand speaker. Covers standard BC, Amer. and foreign shortwave, police, aircraft stations. Authentic Sheraton period cabinet in walnut or mahogany. Philco Corp., Tioga & C Sts., Philadelphia, Pa.—RRT.

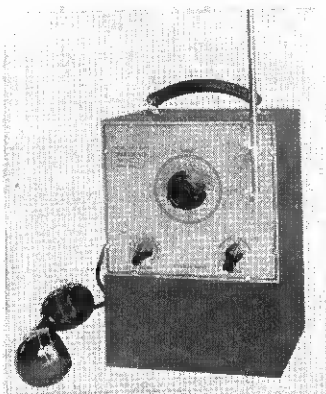

JEFFERSON-TRAVIS MODEL UF-1 ultra high frequency $\frac{1}{2}$ watt, 3 tube transceiver is contained in a black steel carrying case. Comes with carrying case, canvas covering with pockets for handset, antenna and battery cable, telescopic antenna and batteries. Weighs about 16 lbs. May be operated by a vibrapack working from a 12-volt external battery. Jefferson-Travis Radio Mfg. Corp., 380 Second Ave., New York, N. Y.—RRT.

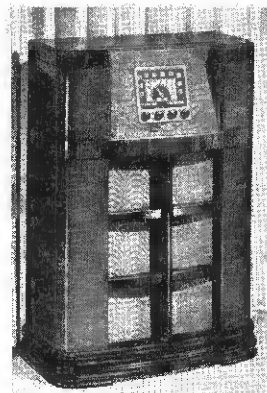

SONORA CONSOLE of rich walnut wood, houses the new 7-tube deluxe AC radio, which tunes 2 bands, 535-1720 kc. and 5.65-18.3 mc. for foreign programs. Built-in super "Sonorascope" loop, clock-type dial, large electro-dynamic speaker, phono-FM-television connection. Sonora Radio & Telev. Corp., 325 N. Hayne Ave., Chicago, Ill.—RRT.

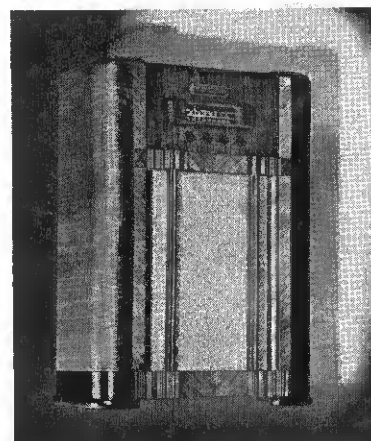

MOTOROLA CONSOLE RADIO, 61K23, with 6 tubes, electric push-button tuning, 10 in. electro dynamic speaker, 3-position tone control. American and foreign reception. Aero-Vane loop antenna. Housed in walnut veneer cabinet. Illuminated dial "slide-rule" pointer. Galvin Mfg. Corp., 4545 Augusta Blvd., Chicago, Ill.—RRT.

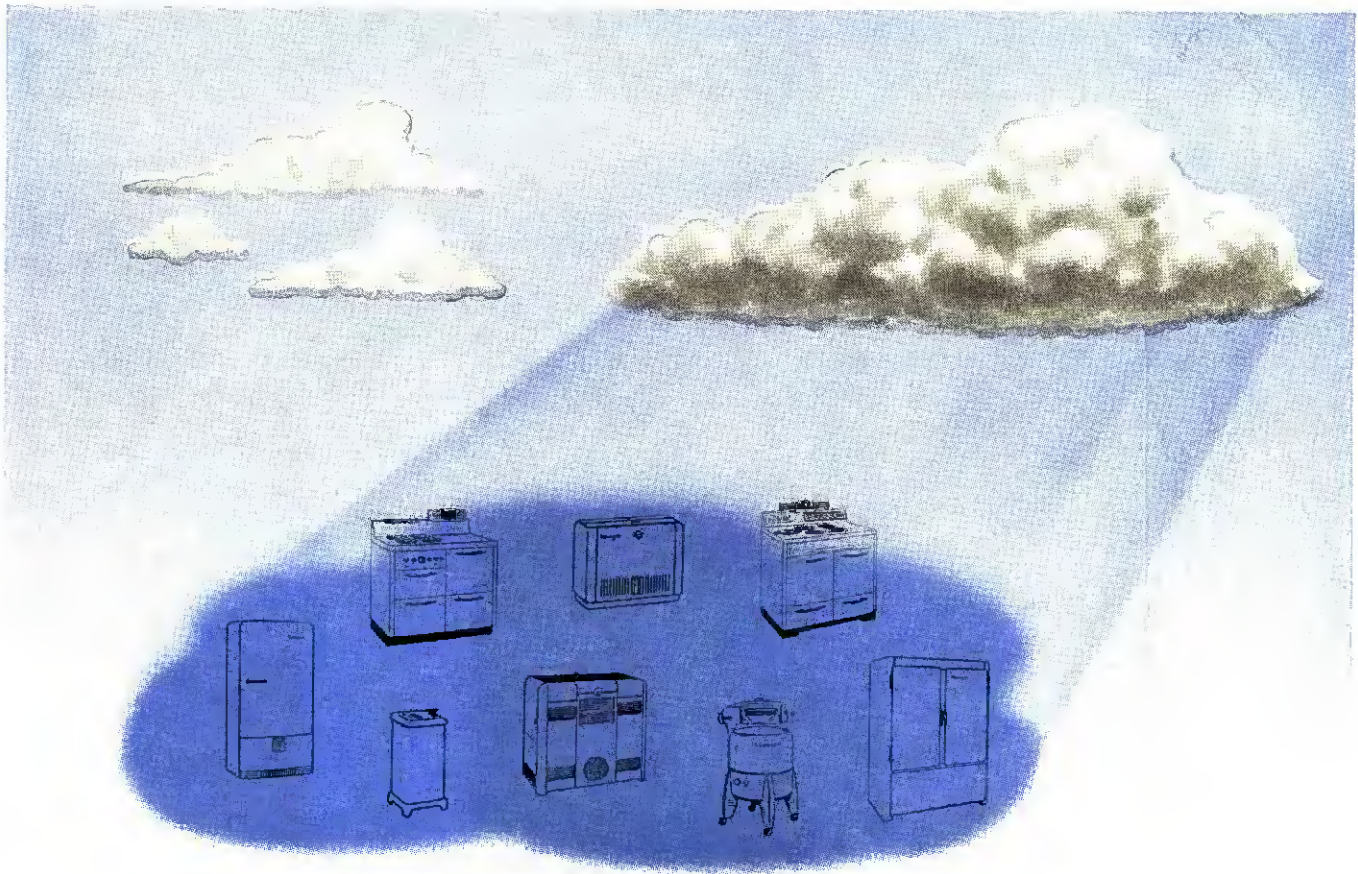

Silver Linings, Inc.

When war comes many things to which we have been long accustomed have a way of going temporarily under a cloud.

In the Norge plants today those superb precision machines that turned out the Norge Rollator mechanism are converted to precision work of quite another nature.

We know you have heard that countless other plants and machines have undergone similar conversions. That is why dealers lack many of the things they normally sell. That is why the public is denied many of the things it normally would buy.

All this is a part of the determined buckling down to see to it that these valued things which have gone under a

cloud do not suffer a total eclipse. Only by so buckling down can we insure the better days to come.

Our great war effort has but *one* aim. Only through winning can we preserve the way of life that enabled the rank and file of our people to have these things that temporarily they must do without.

We must insure that we will have them back. Only by devoting every energy to winning can we hasten the day when such organizations as Norge can again resume leadership in planning further contributions to home health, comfort and economy.

Today, allied with industry as a whole, Norge is busily fashioning a silver lining for this cloud of war.

NORGE



DIVISION • BORG-WARNER CORPORATION • DETROIT • MICHIGAN

ROLLATOR REFRIGERATION • GAS RANGES • WASHERS • ELECTRIC RANGES • HOME HEATERS • COMMERCIAL REFRIGERATION

Recorded Music & Morale

What can recorded music do for national morale? Plenty! It can bring inspiration and courage and refreshment to all of us, wherever we are—at home, in war industries, in factories, in the fighting forces. To attend a concert, listen to a dance band, re-live great moments of history—all are possible just by putting a little needle in the grooves of a record.

The record-player is an invention that has been one of the greatest civilizing forces of all ages, an invention begun and perfected in the lifetime of one man. It is my personal opinion that one of the greatest treasures, of a physical nature, on earth today is a library of recorded music. And now, in addition to music, we can hear through records great addresses such as that of Winston Churchill to our Congress, and President Roosevelt's Declaration of the State of War. We can learn other languages, such as Spanish and French, through records. We can perform music ourselves through the study of records, as has been proven so fruitfully in my own experience.

Music a Tonic

And what have all these things to do with national morale? Everything! Morale is not something separate from the individual, to be put on and off like a hat and coat. Nor is morale something separate from a nation. It is the spirit of a nation, and where is true spirit more surely found than in music?

And isn't it through records that music reaches a great part of our people? A concert hall is as near as the record-player—a concert hall with all the comforts and privacy of home.

As a record-collector of 35 years, I can say that few joys equal that of having on tap all the representative music and songs of great performers and composers. And I can see the trend toward collecting growing hourly.

There's this about record collecting—a man is free to choose the music he wants, without fear of concert hall snobbery or critic-imposed standards.



This exclusive statement by Melville Clark, president of the National Association of Music Merchants, is presented in connection with the celebration of National Music Week, May 3rd to 10th. Mr. Clark heads the 84-year-old Clark Music Co. of Syracuse, N. Y.

If he'd rather collect Blues than Bach, or Goodman than Toscanini, that's his esteemed privilege. That's the way we do it in America.

One word more: I am very much in

favor of our dance bands adapting the classics to their own devices. It's just the old girl dolled up.

Our dance bands get the audiences, and if those audiences become familiar with Tchaikovsky and Debussy and Grieg in this way, when they hear those composers in the original, they will recognize the superiority of the original compositions. Think of the number of people who might never hear the classics at all were it not for our dance bands!

The main thing is this, it seems to me: our dance band versions of classics and classic themes are a definite wedge in the awakening musical consciousness of America. They are like a trowel, and as the point of a trowel is its more important part, because it breaks the ground for the rest of the trowel to follow, so our bands break the ground for a deeper and wider musical appreciation. The jitterbug that today buys a record of *I Think of You* taken from the Rachmaninoff 2nd Piano Concerto, will tomorrow buy the actual concerto.

So let's encourage record-collecting, and let classics and jazz fall where they will. We're rolling in the wealth of recorded music, and our spirit is the better, our morale the stronger for it.

Los Angeles people are in the thick of Pacific Coast war problems, but they want records. Claire's Record Shop provides quiet listening via individual earphones.



**"New Faces on Decca"
for 50c**



Eye-catching counter merchandiser just issued for new 50c discs.

The first release of new 50c records from Decca came on April 2, when the company issued a string of black-label discs by Fred Waring, Deanna Durbin, Kenny Baker, Gracie Fields, Raymond Scott, Lionel Hampton and Harry Horlick. The new platters put new life into the "18M" series, which is familiar to record men; they are introduced via a vigorous promotion under the head "New Faces on Decca."

Sales materials for the new series include window displays and streamers, counter cards, display merchandisers, etc.

Other artists to appear in the new series include Mary Martin, Alec Templeton, Meredith Willson, Irene Dunne, Hazel Scott, and many more. New releases in the "New Faces" group are being made weekly.

**Pan American Records
Featured**

A new publication called "Recordings of Latin American Songs and Dances" is now available to dealers who want to stimulate more interest in discs of this type. It's a 68-page list of popular and folk music, with notes, prepared under supervision of the Music Division of the Pan American Union, and distributed by the National and Inter-American Music Week Committee, 45 W. 45th St., New York City. The books sells to the public at 30c; dealers get it for 21c plus 2c postage.

Music Week this year comes May 3-10, with accent on Inter-American observance, and the two themes, "American Unity through Music" and "Music Maintains Morale."

**Columbia Signs Two
Opera Stars**

The signing of Lauritz Melchior, the great Wagnerian tenor, as an exclusive Columbia recording artist, has been announced by Columbia Recording Corp.

Astrid Varnay, a new Metropolitan opera "find," has also been added to the roster of great operatic stars under the CRC banner.

*Presto
performs better!*



**Check these reasons Why
Presto Glass Base Discs are First
Choice of Recording Engineers**



LESS SURFACE NOISE
—Presto Glass Base Discs have the lowest surface noise or needle scratch of any disc made, permitting unusually wide frequency response.



LONGER LIFE FOR SAPPHIRE CUTTING NEEDLES—Purity of the Presto coating compound, and precision smooth surface greatly increases the life of sapphire cutting needles.



PRECISION SMOOTH SURFACE—Presto Discs have a plate glass base, coated in one operation with a special compound developed by an exclusive Presto formula, assuring a fine, even surface.



FOR ALL TYPES OF RECORDERS—Presto Glass Base Discs have a thickness of .60" to .075", a non-warping center insert with four center holes. They can be used on all makes of recording equipment.



Sold Everywhere. Stocks of Presto Discs are carried in principal cities by Graybar Electric Co. and leading radio parts distributors.



Not Affected By Age. Presto Discs can be kept in stock a year or more without deterioration.



Research Laboratories use the Presto Discs to demonstrate capabilities of the finest vertical and lateral recording equipment.



Majority of larger broadcasting stations and recording studios throughout the world use Presto Glass Base Discs.

**PRESTO
RECORDING CORP.
242 WEST 55th ST. N.Y.**

In Other Cities, Phone . . . ATLANTA, Jack, 4372 • BOSTON, Bel. 4510
CHICAGO, Hor. 4240 • CLEVELAND, Me. 1565 • DALLAS, 37093 • DENVER,
Ch. 4277 • DETROIT, Univ. 1-0180 • HOLLYWOOD, Hil. 9133 • KANSAS
CITY, Vic. 4631 • MINNEAPOLIS, Atlantic 4216 • MONTREAL, Wel. 4216
PHILADELPHIA, Penny. 0542 • ROCHESTER, Col. 5548 • SAN FRANCISCO,
Yo. 0231 • SEATTLE, Sen. 2560 • WASHINGTON, D. C. Shep. 4003

World's Largest Manufacturers of Instantaneous Sound Recording Equipment and Discs

THE BITTER 'SALES-FORCE'
SELLS MORE
RECORDS

SOME USERS

- Steinway Hall
- Carl Fischer
- Gimbel Bros.
- Davega-City Radio (30 stores)
- Radio Corp. of America

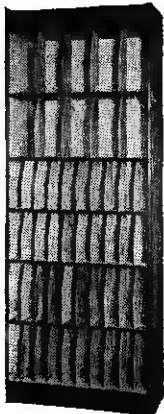

BITTER RECORD RACK #100

An attractive, compact, roomy stock unit. Holds 500 10", 500 12" records and 75 album sets. 2' 10 1/2" long, 7' 2" high, 15" deep. Comes in same design and same standard finish (walnut finished birch) as the Bitter Album Rack No. 110 so that they may be used together.

BITTER SELF-SERVICE RECORD-ALBUM UNIT

The newest member of the Bitter "Sales Force" and already it's setting records for record dealers the country over! Compact, roomy, it moves popular priced stock without a clerk. Slanting face displays about 300 records. Upright face (not shown) displays 16 albums. Lower part stocks 500 records or 75 albums. Suitable for aisle or wall position. Occupies only 5 ft. of floor space. 58 in. high—easy to see over. Provision on top and sides for display material.

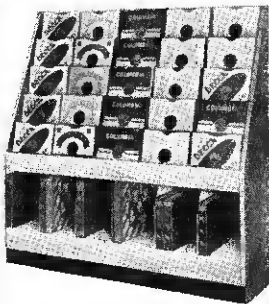

BITTER RECORD BAR*

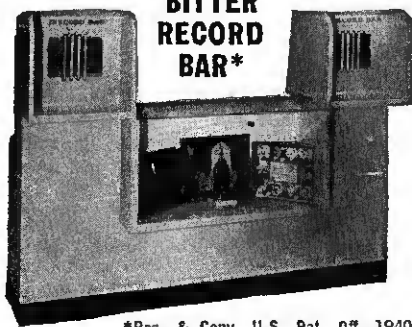

*Reg. & Copy. U.S. Pat. Off. 1940

Step up your record sales with this handy, attractive Record Bar*. It's compact, it's roomy, and it places within arm's length everything you need to make and complete every record sale. Its newest type high fidelity amplifier, feather-light pick-up, and sapphire needle assure highest quality reproduction at all times.

FREE BOOKLET—WRITE NOW!

A. BITTER CONSTRUCTION CORP.
27-01 Bridge Plaza North
Brewster Bldg., Long Island City, N.Y.

RECORD NEWS

Final Set Off Victor's Production Lines

On April 7, the last phonograph-radio to be made by RCA Victor until the war is over, came off the production lines at Camden, N. J. amid special ceremonies. William L. Batt, Raw Materials division director of the War Production Board, was the guest of honor.

The final instrument was marked No. 17,991,547, which is the total number of units made by RCA and its predecessor companies in over 40 years of continuous operation. The instrument was presented to the Georgia Warm Springs Foundation, where it will be sent together with a library of children's records.

Appointments by Columbia Records

Don Law, who was formerly district manager for Columbia Recording Corp., in Dallas, Tex., has been put in charge of Educational and Children's records for Columbia, Bridgeport, Conn.

Mr. Law is succeeded in Dallas by N. E. Chandler, who will be district manager for jobbers in Memphis, New Orleans, Houston, San Antonio, Dallas and Oklahoma City.

Another new district manager for CRC is P. D. (Buzz) Cross, to work with distributors in Indianapolis, Cincinnati, Louisville, Columbus, Pittsburgh, and Charleston, W. Va.

Now You Can Make Trade-in Offers on Records

Now announced on a national scale is the RCA Victor plan whereby the public may exchange old records for new ones. The plan, which has been tested in the East, would give the manufacturer more scrap material which may shortly be needed badly, and it will hike store traffic and sales for the retailer.

Old records, including Victor, Bluebird and Decca (laminated records cannot be used) will be traded for a specified number of new ones. Dealers will turn the discs over to RCA jobbers, who will sell them to Victor. Where the plan has been tried, retailers used newspaper ads, direct mail, radio announcements, store displays, etc., to publicize the exchange, and found that their record sales were boosted as a result.

The recommended list of trade-in values is as follows:

- 10 old records plus 17c gets one new Bluebird
- 15 old records plus 23c gets one new 10 in. Black Label

(Continued on page 42)

Replace
with the
Best!

ALLIANCE
"EVEN-SPEED"
PHONO-MOTORS

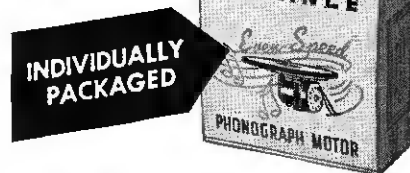
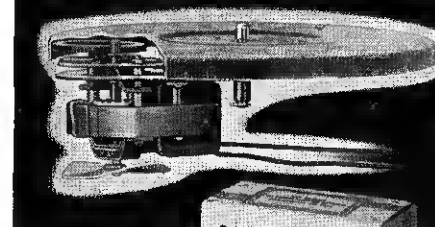

INDIVIDUALLY
PACKAGED

**EASY TO INSTALL...
Fit 95% of all makes**

● The low cost and quick, easy installation of "Even-Speed" Motors make it more practical and profitable to replace the entire unit when trouble occurs than to attempt what may prove to be a difficult repair job. The "Even-Speed" line of only four phono-motors provides a unit for 95% of all replacement requirements. Carry a few in stock for every month will bring a greater demand for replacements.

Each motor and turntable comes in an attractive carton for your greater convenience.

Write today for complete information and low prices on the "Even-Speed" line of phono-motors.

Export Address:
377-379 Broadway, New York City, N. Y.

ALLIANCE MFG. CO.
ALLIANCE, OHIO

75 POUNDS PRESSURE FOR 60 MINUTES
 —AND OUT COMES A *Duck's Back!*



Without moisture-resistance, ducks would be sunk—lack of resistance to moisture can “sink” transformers, too!

Utah transformers get their “ducklike” qualities in the Utah laboratories, where, encased in layers of specially made, moisture-resistant paper, they are heated under 29.4 inches of mercury vacuum pressure for 60 minutes. Consequently, all air is safely removed and all moisture evaporated. Molten wax is then forced into the tank and the empty cells of the insulating paper under 75 lbs. of pressure. This operation re-

quires 60 minutes, but assures a longer life for the transformer.

Utah's extra precautions in the factory are insurance against transformer failure in the field. That is why Utah transformers keep right on performing efficiently day after day—even under severe conditions, when many other transformers would break down. Utah Radio Products Company, 810 Orleans Street, Chicago, Illinois. Office: 560 King Street, W., Toronto. In the Argentine: UCOA Radio Products Company. SRL Cable Address: UTARADIO, Chicago.



UTAH TRANSFORMERS are standard equipment in millions of receivers, all over the world. And there is a COMPLETE line of Utah replacement transformers.



TRANSFORMERS
SPEAKERS • VIBRATORS • UTAH CARTER PARTS

New Equipment

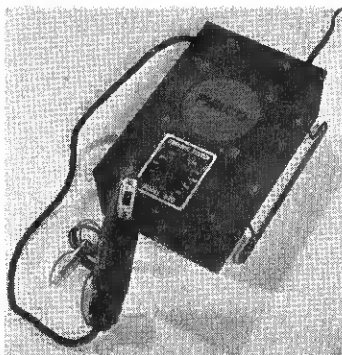

PHILCO DYNAMIC TESTER, model 030, locates trouble in any kind of radio circuit. Small, light and compact. Tester amplifies and reproduces through its own loudspeaker the signal from any part of the circuit—RF, IF, AF. Can be used to trace the signal through the radio & show where the signal is obstructed. Gain in any stage or tube can be checked by loudness of output. Helps test any device which generates a radio-wave signal or noise. Lists at \$19.95. Philco Corp., Tioga & C Sts., Philadelphia, Pa.—RRT

DUNCO LATCH-IN RELAY, type CX3190, operates from a brief impulse, without the necessity of keeping the coils energized. Double-pole, double-throw contacts, rated at 6 amperes at 12 or 24 v. D.C. Auxiliary contact breaks one coil circuit. Struthers-Dunn, Inc., 1335 Cherry St., Philadelphia, Pa.—RRT

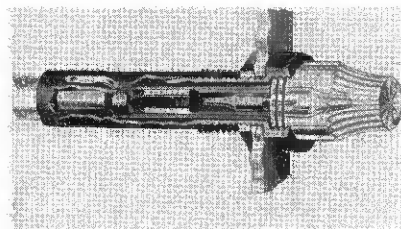

LITTELFUSE PANEL MOUNTING, No. 1414, made for panels up to 5/16 in. thick and 1/2 in. mounting hole. Has black bakelite body and transparent molded cap. Can be had for 24 or 48 v. filament bulb without resistor. Protective resistor, in series with a neon lamp, for higher voltages. Over-all length 2 in. below panel, 7/8 in. above. Littelfuse, Inc., 4757 Ravenswood Ave., Chicago, Ill.—RRT

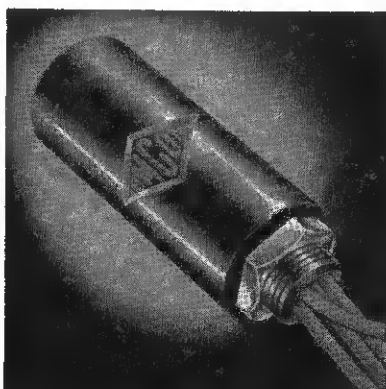

AMERICAN CONDENSER INVERTED TYPE tubular capacitors with lock-nut now available in modern plastics for chassis top installation. Available in single or multiple units over a wide range of capacities and working voltages in both electrolytic and paper by-pass types. Imperviousness to moisture assures wide acceptance for these plastic units. American Condenser Corp., 2508 S. Michigan Ave., Chicago, Ill.—RRT

IRC CONCENTRIC DISC RESISTORS are designed to answer the problem of getting pure resistance loading of low power concentric transmission lines. Available in a variety of sizes and resistance values. Minimum of inductance and capacity. Useful in high frequency measurement circuits, signal generating equip., ultra-high frequency devices. International Resistance Co., 401 N. Broad St., Philadelphia, Pa.—RRT.

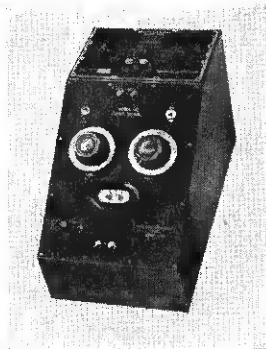

INDUSTRIAL LIMITS BRIDGE for production testing of capacitors or resistors has high speed, rugged separate indicators for low and high tolerances. Two models, LB-1 for capacitors, and LB-2 for resistors both use two cathode ray tuning eyes as indicators. Accuracy of 1% when standards of equal accuracy are used. High and low limit dials are calibrated in percent. Industrial Instruments, Inc., 156 Culver Ave., Jersey City, N. J.—RRT

STANLEY CALIPER RULE for accurate inside and outside measurements. Permits measuring hole diameters from 7/32 in. to 5 in. Graduated by 16ths and 32nds. Packed 6 in a box, \$1.00, each. Stanley Tools, New Britain, Conn.—RRT.

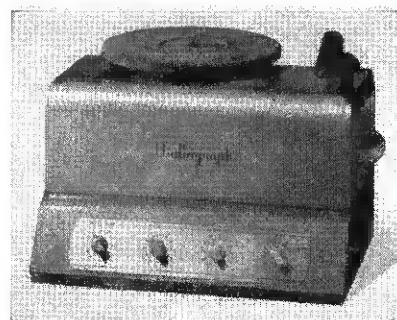

AUDIOGRAPH 40 WATT, 6 V. BATTERY amplifier, BMR-40C, has built in power supply for optional 110 v., ac operation. Switch provides instant changeover from battery to ac operation. Two microphones may be operated simultaneously with separate volume control for each. John Meck Industries, 1313 W. Randolph St., Chicago, Ill.—RRT.

PRECISION VACUUM TUBE multi-range tester, series EV-10, combines both VTVM as well as standard 1000 ohms per volt AC-DC test circuits. Voltage regulated bridge type circuit provides the following ranges on an 8 1/2 in. meter; 8 zero-center VTVM ranges, from ±3 to ±6000 v. DC. Ohmmeter ranges to 2000 megohms. AC & DC voltage ranges at 1000 ohms per volt from 0-3 to 0-6000 v. DC current ranges, 0-600 microamperes to 0-12 amperes. Available as accessory is an RF-10 vacuum tube probe providing direct means for measuring super-sonic, RF & UHF voltages. Precision Apparatus Co., 647 Kent Ave., Brooklyn, N. Y.—RRT



GITS FLASHLIGHT, molded of durable plastic and available in a wide range of colors. A display card is furnished without charge to dealers and displays one of each of three styles manufactured. Gits Molding Corp., 4600 Huron St., Chicago, Ill.—RRT.

GE FLUORESCENT STARTER, FS-4NA, "No Blink" type eliminates the flicker when a fluorescent lamp reaches the end of its normal life by automatically cutting out the dead lamp and thus prolonging the life of the starter. Developed for 30 & 40 w. Mazda F lamps. Standard 2 contact base. General Electric Co., Bridgeport, Conn.—RRT

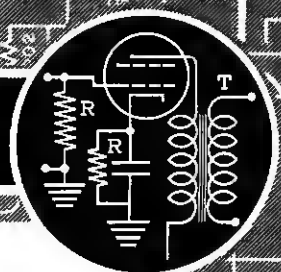

Serviceman Wins Court Action

The legal charge of "unlawfully withholding a radio" has lost some of its sting.

In fact, the possibility that radio servicemen may be successfully faced with such charges while they're trying to collect their service-estimating fees, was considerably weakened last month when the Court of Special Sessions in New York City dismissed the charges against a local radio man.

This was the case of the serviceman who dared to stand his ground, and insisted on his repair estimate fee of \$1, in spite of all the cop-calling and court action that his irate customer undertook. The dealer had his "estimate charge" sign displayed in his store, and also mentioned it to the customer. Yet he was forced into a long series of court appearances because the radio owner denied knowledge of the fee, and refused to pay it. Meanwhile the dealer hung on to the set, with this magazine reporting the case and hundreds of servicemen applauding.

The radio man sailed into the battle because he thought it was high time somebody did something to establish service work as a decent professional skill. He conferred with John F. Rider, well known service author and leader of a local organization to champion servicemen's rights. It was decided that the organization's attorney, Leon Alpert would defend the dealer as a test case.

Not Criminal Case

The charge was petty larceny. After a number of hearings and delays, Mr. Alpert moved to dismiss the charges on the ground that no larceny had been proven, and that the complainant's remedy, if any, was in a civil court inasmuch as the defendant asserted a lien against the property involved. The three judges hearing the case then dismissed the charges.

Specifically, it would appear that the only point established here was that such cases call for civil action, rather than criminal. As Mr. Alpert puts it, "sufficient lien rights are asserted to eliminate possibility of criminal conviction for unlawfully withholding property under the circumstances involved . . . a determination as to the actual lien rights of the serviceman would have to be left to the civil courts, and it is my opinion that such lien exists but nevertheless should be strengthened by legislative action."

It seems that such a civil case would have to be tried under the lien law applying to artisans' services, which contains no specific references to the type of work which is done by radio men.

There is one step, however, that radio men can take now. And that is to be sure that the customer receives formal and unmistakable notification that a service estimate charge will be made. Printed claim-checks or tags, which constitute a contract and leave no doubt about the agreement, are the best, although prominent display signs and verbal mention are usually enough.

These steps should be taken to avoid all court action, civil or criminal, and are of special importance in these times. The serviceman's time is now more valuable, and if his charges are questioned to any degree, it will have a particularly unfortunate effect on his business.



Modernizing Old Sets

How to add new circuit features to old models while repairing them for the "duration"

• Servicemen can do a great deal toward improving the usefulness of many old sets which will have to be kept operating for some time to come. Set modernization can be of real advantage to both servicemen and customer.

The modernizing features which can be added to old sets are almost without number. Improved tone quality and tone control are two services which will do much to better performance. Elimination of obsolete parts by new circuits will make it possible to handle these jobs.

Most people have a "tin ear". They have become so accustomed to the limited range of the telephone, their old radio, poor phonographs and old records, that it is hard to convince them that there is anything better to be had. While these improved tone jobs require some selling, you can do it. These jobs need not be in contradiction with the national policy to conserve materials, since many of the repair jobs you will have in your shop call for a new speaker, new volume control, etc. Here you have the basis of a tone improvement job. By using the correct speaker, a tapped volume control, a by-pass condenser and a couple of resistors the quality of the

majority of the old sets will be noticeably improved.

Tone Compensation

On those sets that do not have a diode type second detector circuit, the tapped volume control adapted for bass compensation will usually be placed in the grid circuit of the AF amplifier. That is, unless the set is also changed to incorporate a diode detector and AVC. Most of these old sets have a plate or grid-leak type of second detector and the volume control is a gain control changing the bias on the RF or IF tubes. This gain control can be replaced with a fixed resistor of the value usually found as a minimum bias control. In order to prevent the tubes from overloading at the maximum volume end of the gain control, a 300 to 500-ohm resistor allows a minimum bias to be maintained on the tubes. In most cases, the gain control used to change the bias can be removed and replaced by a 300 to 500-ohm resistor unless one is already in the circuit, in which case the circuit is completed to ground or to whatever point the variable control was connected. If the set is being used in a locality close to several powerful stations, and therefore maxi-

mum sensitivity is not required, the bias resistor can be increased slightly. The value should be one that causes the set to play somewhat louder than would ever be used. Since it is proposed to control the volume at the audio end there is no need of having the RF end of the set run at full blast if it is not required due to powerful local stations.

Circuit Constants

The mounting hole left by the RF gain control will take the tapped audio volume control. The standard tapped controls for bass compensation circuits run from $\frac{1}{4}$ to 2 megs and are usually tapped at $\frac{1}{4}$ to $\frac{1}{2}$ the total resistance. The tapped point determines the volume level at which the compensation is greatest. The amount of compensation can be adjusted by changing the value of the resistor R_c (see Fig. 1) between 20,000 and 100 M ohms. The shunt capacity between the resistor and ground can also be varied from .005 to .02 mfd. for different degrees of bass compensation. The larger values of capacity and lower values of resistance will give more apparent boost to the bass.

If it is desired to vary the tone compensation, a tapped switch can be put in to change the value of capacity to ground, or the resistor R_c can be made variable. If a variable resistor is incorporated, it should be about 50,000 ohms with an additional 20,000 ohm fixed resistor in series to act as a limiting value.

The details of tone control circuits were covered in the June, 1941, issue of RADIO TODAY, page 42. Re-read this material for details of a number of tone and bass compensation circuits.

AVC Circuits

Automatic volume control is an important feature that many of the old receivers are lacking. It can be added with a few inexpensive parts to the majority of early supers. Some TRF sets may have sufficient gain in the RF and audio end to permit a diode detector to be used thus giving AVC voltage.

Most of the sets without AVC systems use 2.5 volt tubes. The three most common 2.5-volt tubes for use as a diode second detector and an audio amplifier are the 55, 2A6 and 2A7. The 55 has a low-mu triode section, the 2A6 a high-mu section, while the 2A7 has a pentode in the same en-

Fig. 1 A & B. Two tapped volume control tone compensation circuits for use in old sets. Circuit A is designed for use in sets with the volume control in the grid circuit; B for conventional second detector circuits.

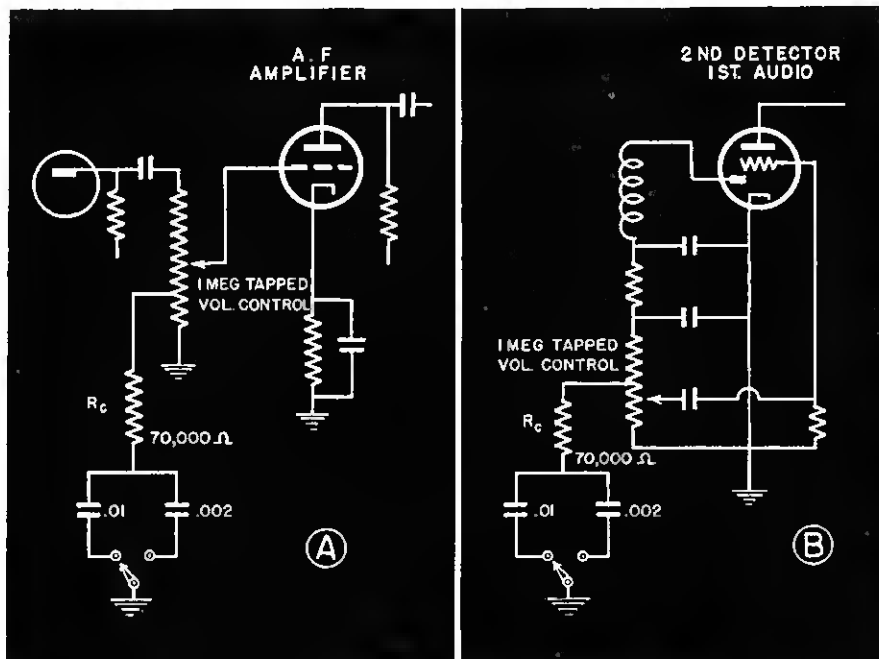

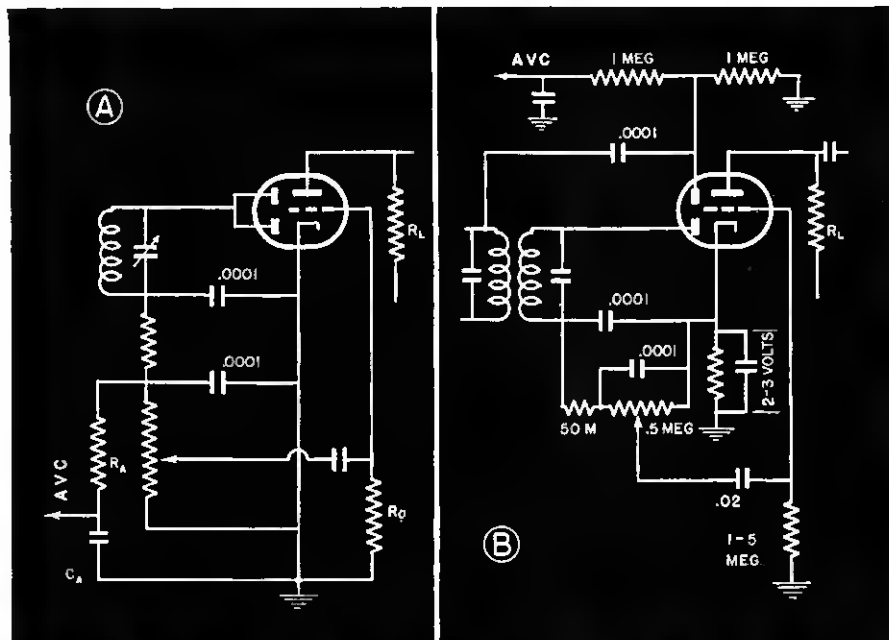

Fig. 2 A & B. AVC systems in connection with diode second detectors can be simply added to most sets. Circuit A filters the audio from the output of the detector. Circuit B develops AVC voltage in separate diode circuit.

velope with the two diode plates. In most cases, the old second detector tube was a low- μ triode such as a 27, or 56. If this tube was transformer coupled to the following audio stages, the tube to be used as the new second detector should match the transformer as nearly as possible. In the case of the 27, or 56, this means that the 55 should be used. If the audio transformer is old and noisy, it can be replaced with a resistance coupled circuit if the following stage is not push-pull. If resistance coupling is used, put in a 2A6 or 2A7 to make up for the gain lost in removing the transformer.

The socket will probably have to be changed in most sets since the 55 and 2A6 have 6 prong bases and the 2A7 has 7 prongs.

Installing Diode Detectors

There are many diode detector, AVC, first audio circuits which can be used for modernizing old sets. All of the detectors circuits are quite similar and the main differences exist in the AVC system. Two common types of second detector circuits are shown in Fig. 2. The circuit in Fig. 2A does not have the delayed AVC characteristics of Fig. 2B.

The series combination of the volume control and the 50,000 ohm fixed resistor forms the DC load resistance for the diode rectifier detector. Shunted across the volume control, which is the larger portion of the DC load, is the series combination of the AVC filter resistor and filter condenser. The series combination of the audio coupling condenser and audio grid-leak is also in parallel with the section of the the volume control from the sliding tap to ground. The effect of these two

circuits across the volume control is to reduce the effective impedance or load when audio modulation is present on the carrier. Since the reactance of the capacitors in the circuit changes with frequency, the load impedance to the audio signal is not constant and therefore causes distortion. For more complete details on this effect of additional loading when an AC signal is present see pages 30 and 31 in the August, 1941, issue of RADIO TODAY.

Component Values

In order to reduce the effect of this loading and distortion of the audio signal, make the resistance in the AVC filter as large as possible and the filter condenser C_a as small as possible, but still do a good job in their circuit. Likewise, make the audio

Fig. 3. Tuning eye tubes can be easily added to sets with AVC. R_t should be value which allows the eye to just close on strong signals.

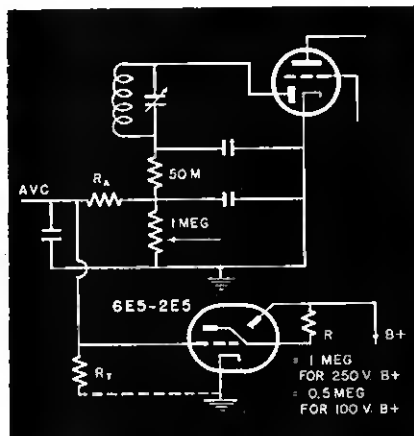

coupling condenser small and the grid-leak large. These values will reduce to a minimum value the load which shunts the volume control whenever an AC signal is present. The value of the AVC filter resistor and condenser are determined by the time constant desired for the action of the AVC and by the minimum value of resistance allowed in the grid return circuit of the various controlled tubes.

The time constant for the AVC circuit should be such that for high fidelity work the lowest frequency audio signal does not allow the system to operate and reduce the percentage of modulation. If time constant of the AVC circuit is too short, 0.1 second or less, audio tones in the vicinity of 100 cycles per second will of course change the carrier strength at a rate which the AVC system will try to compensate. Thus the AVC system with a short time constant will have the effect of reducing the strength of the low frequency tones.

Time Constants

The time constant for ordinary broadcast receivers should be 0.1 to 0.3 seconds; good fidelity broadcast receivers should have a constant of 0.25 to 0.5 seconds; dual or triple band receivers require a shorter time constant to take care of the rapid fading prevalent on those bands; about 0.1 to 0.2 seconds. This time constant is conveniently calculated by multiplying the value of the AVC load resistance in megohms by the capacity of the AVC filter in microfarads. This is the time constant for charging the capacitor and is approximately the time required for the system to act on an increase in signal strength. The discharge time for the system is greater, the amount depending upon the type of circuit used. In Fig. 2A, the discharge current from the AVC filter capacitor must flow through the AVC filter resistor and the volume control to ground. Since the total resistance in the discharge circuit is greater the time constant is also greater.

Where several stages are controlled by the AVC system, the total AVC filter capacity is the sum of all the capacities from the AVC bus to ground. Usually each stage has a 100,000 ohm resistor for decoupling purposes. Since these resistors are usually small compared to the AVC filter resistor their effect on the time constant is not of great importance.

Controlled Stages

As mentioned previously, it is good designing to make the AVC load resistor large and the capacitor small to give the desired time constant and limit the AC loading of the diode circuit. The resistor in the AVC circuit should be such to keep the total

(Continued on page 32)

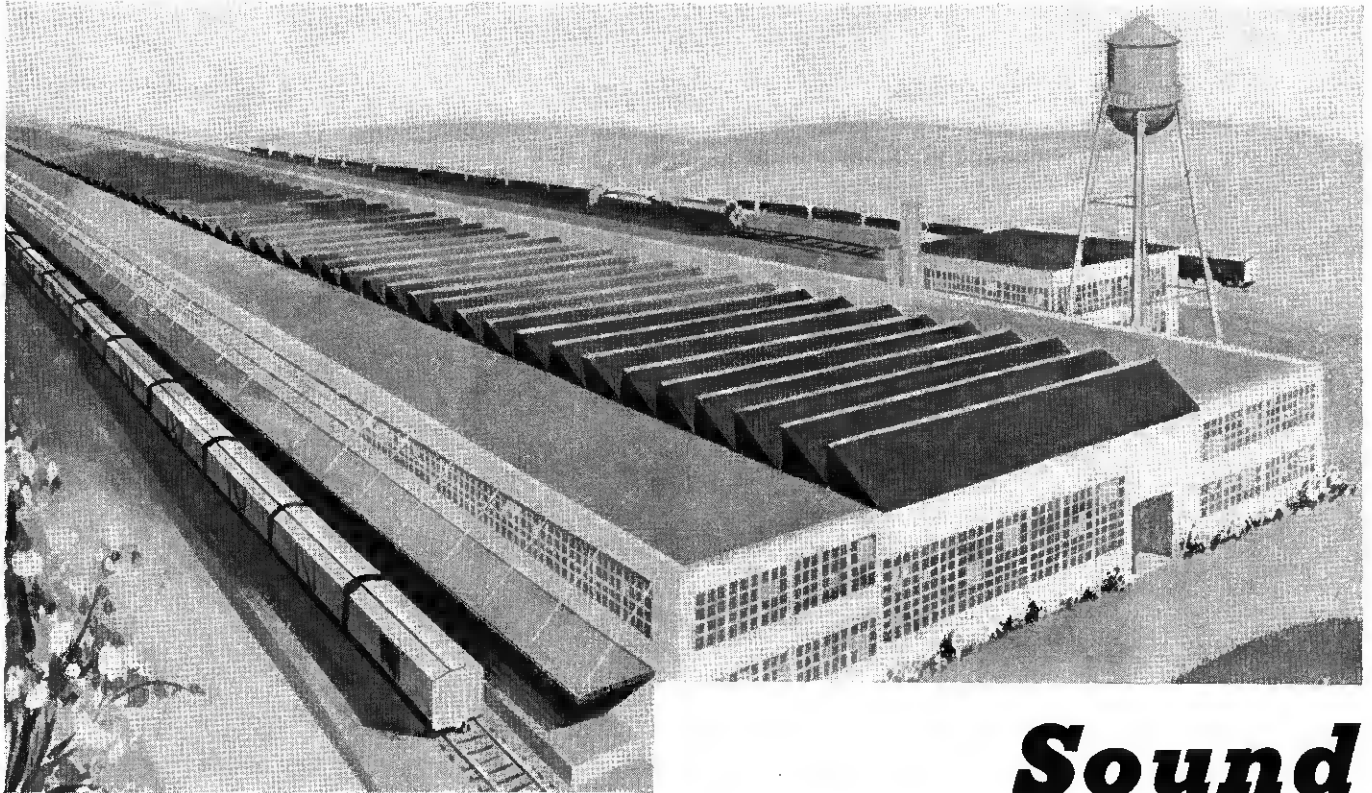

Sound in War Plants

• As defense plants grow, as the demands made for and upon sound distribution systems increase, the functions and design of such systems become more complex.

The requirements of defense plants today are of such nature that the simple mike - amplifier - speaker arrangement of yesterday has in many cases been found to be inadequate. As in many fields, war and war demands have helped sound distribution systems to "grow up."

A typical system, manufactured by the David Bogen Company, Inc., has been installed in several U.S. war plants, and is described by Sidney Harman, sound engineer, as follows:

The system provides announcing, paging, air raid and fire alarm features, all controlled locally and remotely.

Interlocked Controls

The telephone operator is provided with a control unit with which she is able to page through all speakers in the system simultaneously. The control box is equipped with a lever-type switch arranged to control a remote relay which supplies the plate voltage for the pre-amplifier connected to the telephone operator's microphone and for the low voltage pilot lamps located at both the telephone operator's control box and at the watchman's control box. These pilot lights indicate when the system is in use.

The watchman's desk is also equipped

with a control unit, as illustrated, which permits the making of announcements and the issuance of air raid directions. The control box is provided with two lever-type switches, one of which controls his microphone and the pilot lights at both the telephone operator's desk and at the main gate. This switch also controls a remote relay which, when the watchman's station is in "talk position," locks out the telephone operator's relay, thereby giving precedence to the watchman's call. This is most advisable for it prevents the telephone operator from interrupting emergency announcements.

The second key controls the air raid relay which is arranged to connect a tone generator to the input of the amplifier. This relay is so arranged that it locks out both the watchman's and the telephone operator's microphones when in operating position, giving the air raid signal precedence over both microphone inputs. The advantage of such operation is obvious.

Alarm Tone Generators

The tone generator is located on the relay panel as shown in the construction view of the amplifier rack. Means is also provided for connection of a supervised shunt coded fire alarm system, through a supervisory panel located at the watchman's desk. An auxiliary four pole, single throw relay is installed on the fire alarm super-

visory panel, arranged to control both the fire alarm relay and an automatic timer. The fire alarm relay switches another tone generator into the input of the amplifier and operates in such manner that it disconnects the air raid tone generator when in the "operating" position. Precedence has been given fire alarm over air raid

Microphone and control box used at watchman's desk. Switches control air-raid alarm and "talk" relays. Similar unit at telephone board.

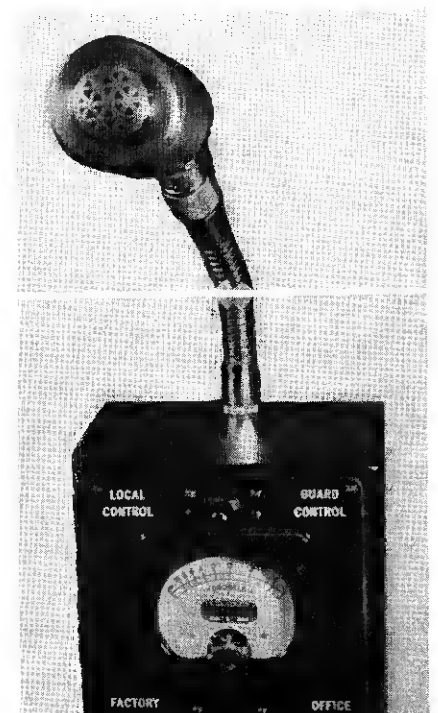



because experience in English plants has indicated that considerably greater damage in life and property can result from fires than from direct raids. This is true regardless of whether the fire is caused by a raid or not.

Equipment Controls

When the master switch is turned on, the filaments of all tubes are lighted and maintained at operating temperature. Each amplifier in the rack is provided with a master relay which supplies plate current to its respective amplifier and is controlled by the microphone, air raid or fire alarm relays, arranged so that the amplifier is supplied with the proper plate voltage whenever the control relays are in operating position.

The amplifier rack is constructed of heavy gauge steel with a baked enamel, ripple grey finish and jet black metal trim. It is equipped with a tone generator and relay panel, one Bogen model E30 30-watt driver amplifier and 6 Bogen model E100 100-watt booster amplifiers. The driver and booster amplifiers are individually mounted.

On the relay panel are mounted the two tone generators, the input control relays, the plate supply relays and the automatic timer and cycling device for the fire alarm. The tone generators provide a constant tone, one of which is tuned to a frequency of 1500 cycles and is connected to the input of the amplifier through the air raid control relay. The other generator is designed to provide a tone signal tuned to a frequency of 800 cycles and is connected to the input of the amplifier through the fire alarm control relay.

Volume Control Circuits

The driver amplifier is of single unit construction, consisting of a voltage amplifier section and a driver power amplifier section. The voltage amplifier has three inputs, two are of 50 ohms impedance, each having a tri-alloy shielded transformer coupled to separate 6SF5 tubes. The outputs of the 6SF5's are connected to separate gain controls, each providing a linear and noiseless attenuation of the gain of its respective stage without introducing distortion or frequency discrimination.

All controls are provided on the front panel of the amplifier. The outputs of the two gain controls are fed (through resistance networks, designed to eliminate the possibility of either gain control effecting the other) into one section of a 6F8G tube.

The third input channel is fed through a gain control, similar to the one just described, into the remaining section of the 6F8G dual triode. Each gain control circuit is further

designed so that, should it be desirable, attenuation may be controlled from a remote point through facilities provided for this purpose on the rear of the chassis.

Output Control

The driver amplifier is further provided with a bass-treble equalizing circuit. A special inverse feedback circuit, feeding from the outputs of the amplifier into the grid circuit of the 6F6G tube in its respective channel, is designed to feed a degenerative voltage into the control circuit in such a manner that a constant output is maintained within 3 d.b. from no load to full load. Thus changing the number of speakers in the system, and consequently the load, does not alter the output over 3 d.b.

The inputs of the 100-watt booster amplifiers are connected in parallel to the output of the driver amplifier. The output transformers in each booster amplifier are designed with a two-section secondary, one having output impedances of 2, 4, 9, 15 and 72 ohms; and the other 84, 100, 125, 166, 250 and 500 ohms. Each amplifier has an output of 100 watts with a distortion factor of not more than 5 per cent with all harmonics arithmetically added and the outputs of the 6 power amplifiers are connected in parallel and provide a total output of 600 watts.

Reproducers have been selected in

Rack mounted equipment consists of 30-watt driver amplifier, six 100-watt power amplifiers, fire and air-raid tone generators, switching relays and controls. Stands supporting control boxes are not part of equipment.

How Sound Helps In Wartime Industries

1. Provides instantaneous mass communication for announcements, instructions, etc.
2. Serves as air-raid and fire alarm system.
3. Gives paging and coordinating service.
4. Helps build worker morale and reduce fatigue when planned music programs are presented.
5. Amplifiers, speakers, microphones, etc. help test war products.

terms of area to be covered, noise level which exists, type of machine employed in the area, and temperature and moisture conditions.

Systems such as the one just described are being employed in defense plants throughout the country today. Variations may provide phonograph and radio distribution, but all are helping to step up efficiency, production and safety to an amazing degree.

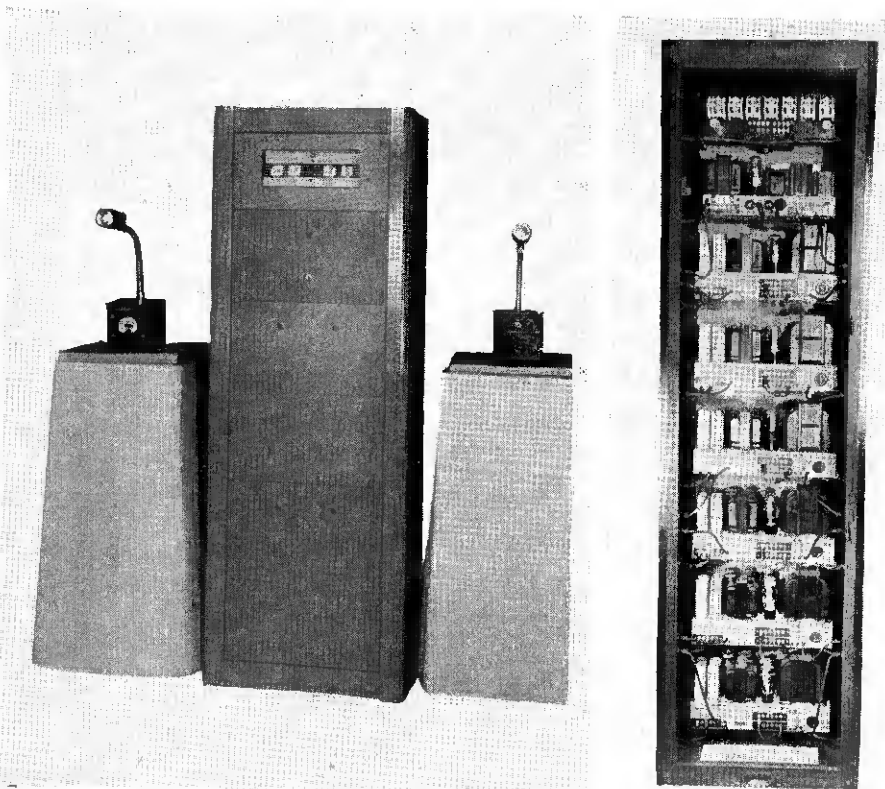



MODERNIZING OLD SETS

(Continued from page 29)

resistance from any controlled tube to ground about 3 megs for one controlled stage, 2.5 megs for two controlled stages, and 2 megs for three stages. Add all the resistances in the return path to ground and make the AVC load resistor the difference between values above the sum of the other resistors.

After the value of the AVC filter resistor is determined, the correct value of capacity for the filtering can be determined by dividing the desired time constant in seconds by the resistor value in megohms.

For the AVC system to be most effective, the controlled tubes must have a variable mu characteristic. In old sets, having sharp cut-off tubes such as 24's, 57's, etc., it is necessary to replace them with 35's, 58's and similar super-control tubes. AVC is usually applied to the RF stage, converter, and first IF stage. If two stages of IF are used in the set it is preferable to operate the second stage with fixed bias to prevent modulation rise and accompanying distortion.

Tuning Eye Circuits

Tuning eyes are popular additions which can be easily put into AVC sets. Fig. 3 shows the typical connections for the most common type of cathode ray tube. The 2E5 tube with a 2.5 volt filament is no longer made but may be found in some tube stocks. The 6E5 is a popular type. The tuning eye can be adjusted to just close on the strongest signals by supplying its grid from a high resistance voltage divider from the AVC network. The 6E5 closes with about -7 volts. To prevent over-lapping on strong carriers, the grid of the 6E5 should be tapped on a divider to receive from 1/2 to 3/4 of the total AVC voltage.

Bias Circuit for Battery Portable Receiver

The method of obtaining the correct grid bias for the various tubes in the circuit of the Zenith portable 7G605 is shown in the accompanying diagram. The familiar series string of filaments is arranged to put the 3Q5 tube filament 4.5 volts above ground so that the grid can be returned to the negative end of the string to give the required -4.5 volts grid bias. The other tubes are placed in the circuit to keep hum at a minimum. The IF and RF tubes have grid returns to their own filaments for approximately zero bias operation.

The automatic volume control circuit is more complicated in the series filament type of circuit when the diode detector is not at the ground or negative end of the string. In the 7G605 circuit, a high resistance voltage di-

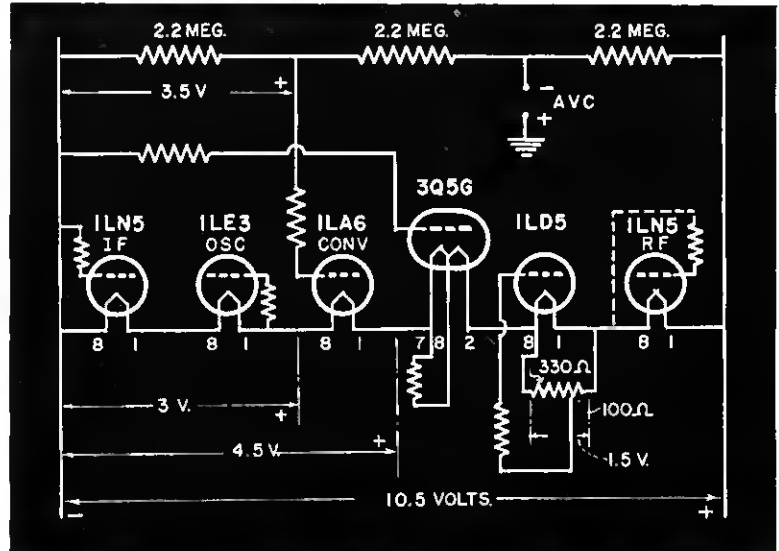

Filament connection diagram for Zenith portable 7G605 showing AVC and fixed bias voltages. One half the AVC voltage is applied to the converter.

vider is shunted across the entire filament string and the AVC voltage is fed into this divider at a point 2/3 of the way up from the negative end. This point is 2/3 of 10.5 volts or 7 volts while the negative end of the second detector filament is 7.5 volts above the negative end of the string. This places a potential of 0.5 volts negative on the diode plate.

Divided AVC Voltage

Since the filament of the converter tube is 3.75 volts (to the center of the filament) above the negative end, its grid must return to a point of approximately the same potential to avoid any initial bias on the tube. In this circuit, the grid is connected to the AVC divider work at a point 3.5 volts above ground. This puts an initial bias of approximately -.25 volts on the converter grid. This divider system applies 1/2 of the AVC voltage to the converter.

Radio Service Methods in England

A recent letter, to the editors of RADIO RETAILING TODAY, from a former serviceman in the U.S.A. now serving with the Canadian Army in England, tells an interesting story about the types of circuits and service problems due to shortages of parts over there. The following paragraphs are quoted from his letter.

"In the British Isles, radio receivers are taxed by the Government, the tax being graduated according to the number of valves (tubes) in the set. This tax has led to the extensive use of copper-oxide rectifiers wherever possible to eliminate an electronic rectifier, as in second detector, AVC, rectifier, monitor detector, etc., circuits. They are also used in crash level controls.

Fig. 1 in the accompanying draw-

(Continued on page 34)

Typical English receiver circuits using copper oxide rectifiers in place of electronic diodes. See story above.

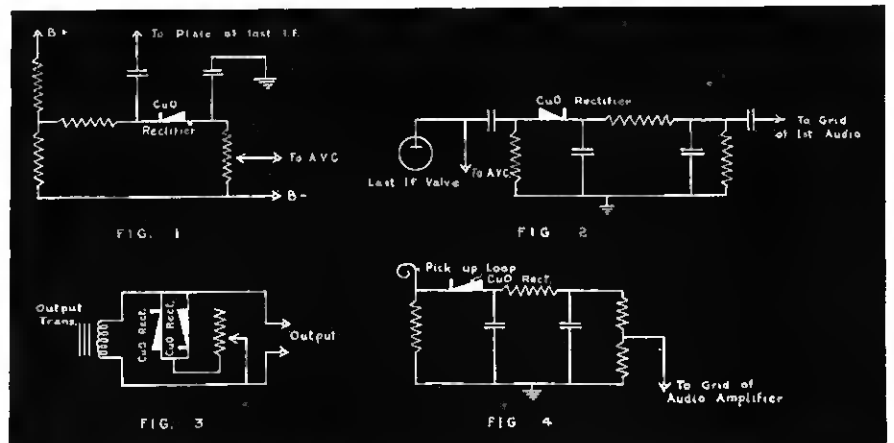

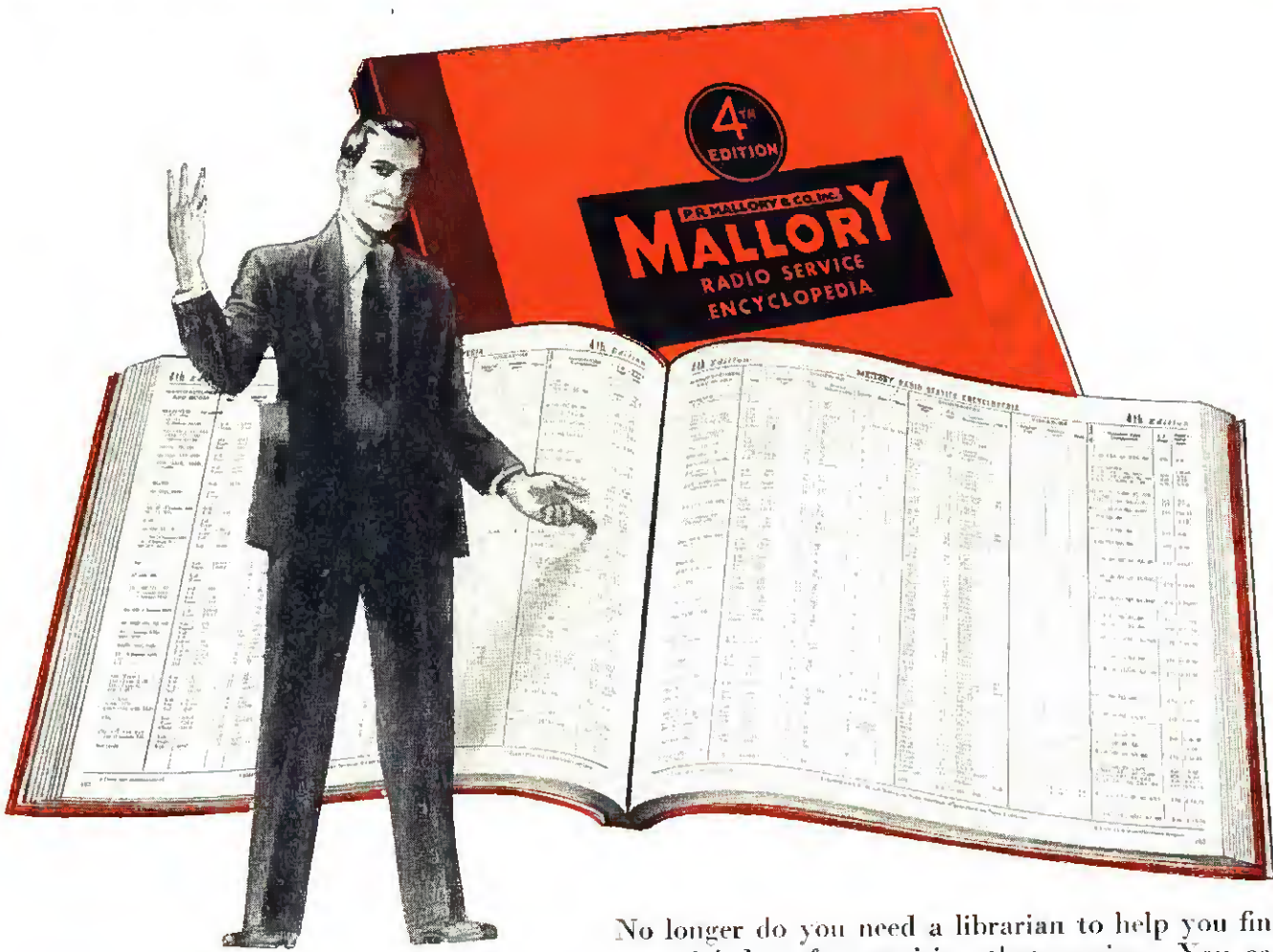

**“All Three—At Your
Finger Tips!”**

No longer do you need a librarian to help you find essential data for repairing that receiver. You can stop the bother of referring to volume control guides, condenser manuals and vibrator recommendation lists every time you service a receiver. It's an unnecessary waste of time, because data on *all three*—volume controls, condensers and vibrators—and more—is instantly available from the Fourth Edition “MYE”.

It's like having a factory engineer at your elbow. In one compact listing, on one page, you'll find the information you need to make a speedy, satisfactory repair of *any* model of any receiver . . . circuits, original part numbers, recommended replacements for volume controls, condensers, vibrators.

Too, the “MYE” gives you the tube complement, the I.F. peak and the Rider's Reference, if you have to make a detailed inspection of the entire schematic.

Ask the man who owns an “MYE”. He's bound to be enthusiastic about it. He'll tell you how it has saved him dollars and days. Then get *your* copy right away from your nearest Mallory Distributor. If you're busy trying to “keep 'em listening” in your community, you can save yourself time and money by getting a copy of the Fourth Edition “MYE”. Better hurry . . . the supply is limited.

P. R. MALLORY & CO., Inc.
MALLORY
Approved Precision Products

P. R. MALLORY & CO., Inc.
 INDIANAPOLIS INDIANA
 Cable Address—PELMALLO



ing gives the skeleton outline of how these copper oxide units are employed as AVC rectifiers."

(Note the capacity coupling of the rectifier to the plate circuit of the last IF stage and the adjustable voltage divider in the AVC circuit. This AVC rectifier circuit is connected to the second detector circuit shown in Fig. 2.)

"Fig. 2 shows how they may be employed as diode rectifiers for the second detector in super-heterodyne receivers. Fig. 3 is an example of their use as a crash level control. The characteristic of these rectifiers is such that surges, as loud peaks of noise, are shunted out while the normal volume is only slightly affected. Fig. 4 shows the oxide rectifier as used by transmitting stations to rectify the carrier and deliver a signal for monitoring purposes.

Replacement parts for commercial receivers are difficult to obtain. This prompts the serviceman to draw upon his ingenuity in devious ways. Seldom is a receiver returned to the customer with the circuits as designed by the manufacturer. Transformers are by-passed, coils are shunted, stages are eliminated, AC sets are converted into AC-DC models, and multi-band sets are more often than not, returned as single-band receivers."

1942 Replacement Vibrator Guide Issued by Mallory

A complete new guide to replacement of vibrators in auto and battery operated home sets has just been released by the P. R. Mallory & Co., Inc.,

Indianapolis, Ind. In addition to the tabulation of set models and appropriate vibrator types, there is a cross reference list of Mallory vibrator types and the set models using each particular type. A special section of six pages gives important facts on the installation of sets in 1942 cars. A check chart gives the location of special grounds and points to be by-passed for noise elimination. Two pages of drawings show just where the ground or by-pass is to be installed.

The details of a correct service procedure for vibrator type sets are included in this guide, and the following information is quoted from it.

Use a DC ammeter of approximately 0-20 ampere range to check the input current to the set. If the input current to the set is more than one ampere above the value stated in the set service bulletin at the voltage value given, usually 6.3 volts, replace the vibrator with a known good unit and recheck. If the current input is still high, turn set off and look for trouble at the following sources: (1) Replace the rectifier tube with one known to be good. (2) Check the secondary buffer condensers for opens or shorts and replace if necessary. (3) Check by-pass condensers, especially those in screen grid circuits, for shorts or leakage. (4) If hash by-pass condensers are used across the elements of the OZ4 tube, these should be rechecked. (5) Check the filter condensers for shorts or leakage. (6) Check tubes for shorts. Output tubes are especially likely to develop short circuits. Also check bias voltage on output tubes.

General Electric Model L-660 Circuit

This AC/DC receiver has push button tuning, tuned RF stage, and a phono input jack. The circuit is shown in an accompanying diagram.

The push button trimmers are adjusted through the bottom of the set. The rows are labeled Osc. and RF. The left-hand pair of trimmers is for the left-hand key, and so on, across the row. The set should be allowed to run for 15 minutes before adjustments are made.

Alignment

The 455 kc. signal is applied to the 12SA7 converter grid through a 0.05 mfd. capacitor. Align progressively the trimmers in the second and first IF transformers for maximum output.

The RF alignment must be made with the loop antenna bolted to the chassis. Since the glass dial scale is fastened to the cabinet, alignment must be performed with the punch marks in the reflector plate back of the pointer. From left to right these reference marks correspond to 550, 1000 and 1500 kc. The signal should be coupled to the loop antenna with a two-foot piece of wire on the signal generator post and kept about two feet away from the set.

With the set turned to 1500 kc. and the generator to the same frequency, the oscillator trimmer should be peaked and the antenna trimmer adjusted for maximum output.

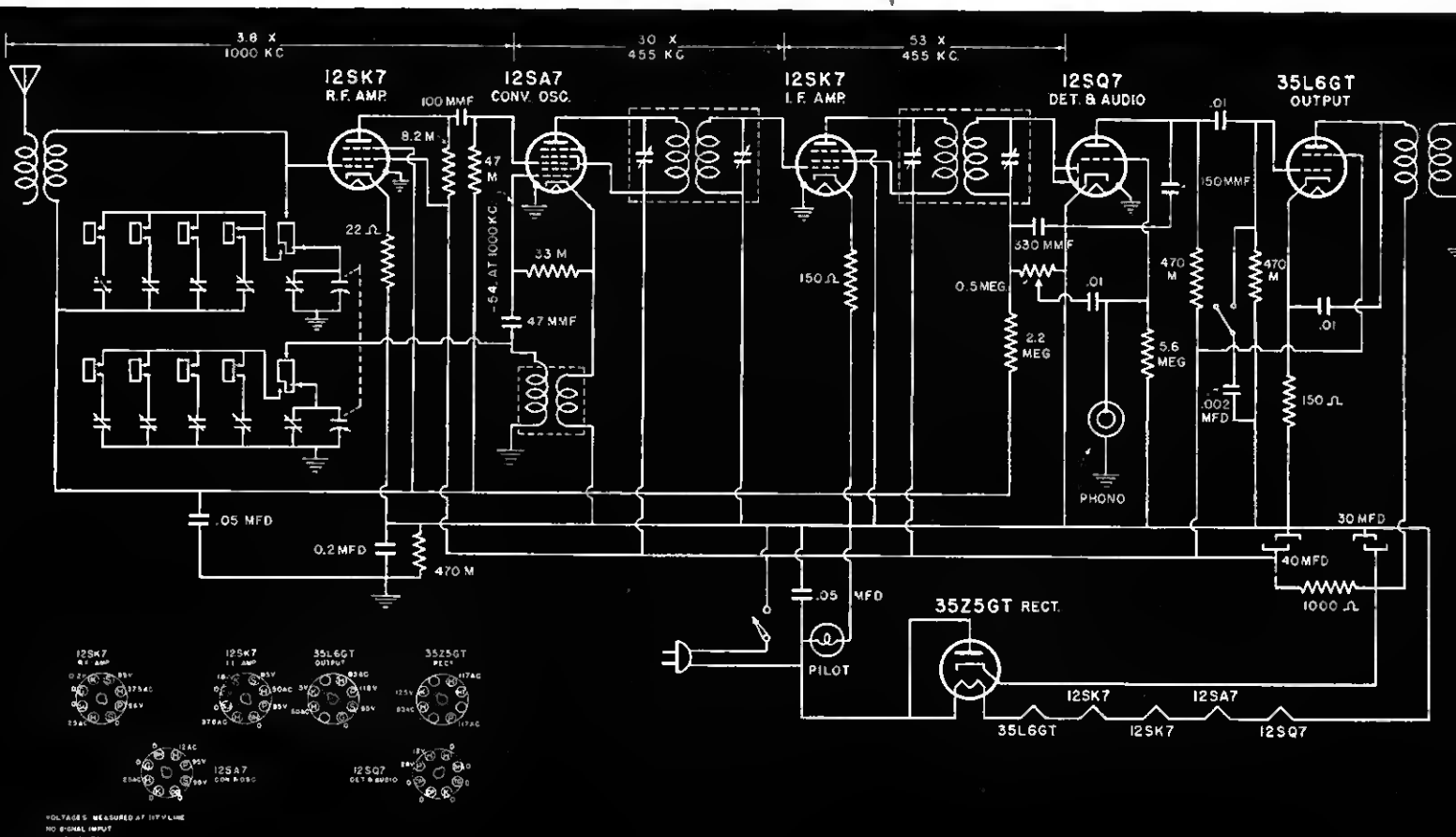



HOW MANY VOLUME CONTROLS MAKE A SERVICE STOCK?



**"Not Many!...
When They're IRC
Type D Universals,"**
says busy **GENE KOEHLER**
of **GIMBELS**

Probably one of the busiest radio service departments in the East, is that of Gimbel's department store in Philadelphia, managed by Gene Koehler—and there you'll find the IRC Volume Control Cabinets with their 18 Type D Universal Tap-in Shaft Controls on the job in a big way.

"I've never checked your claim that the 18 controls in this cabinet will handle up to 87% of all control replacements," says Mr. Koehler, "but it sounds just about right. In handling hundreds of jobs a month, we seldom have to buy a control type that isn't included in the cabinet. This means a big saving in our time and a worthwhile increase in our efficiency—especially today when it is often difficult to get certain special controls.

"Often, when we think we're 'stuck' for a replacement that might take time to get from the factory, we're pleasantly surprised to

find a control of the proper electrical specification in the IRC Cabinet. Then, all we have to do is select the proper Tap-in Shaft. Seldom do we get a job where one of the four available IRC Shafts will not fill the bill.

"The IRC Control Kit also makes it easy to check our control stock. Actually, in a shop the size of ours, we have three Cabinets, each containing the full 18-control assortment so that we won't run short of any item on busy days. A glance at the empty compartments then tells us in an instant just what controls should be re-ordered.

"Type D Controls with Tap-in Shafts are a great idea—and so are the Kits. We certainly wouldn't want to be without either!"

Take a tip from Mr. Koehler! Put your servicing in tune with the times. See the IRC Master Control Kit at your IRC jobber's today.



Type D UNIVERSAL CONTROLS ... WITH TAP-IN SHAFTS



Four shaft types make it easy to select the right one for almost any job. Will not pull or vibrate loose, once tapped securely into the control socket.

HANDLES 4 OUT OF 5 JOBS!... The 18 Type D Controls, 6 switches and 5 extra shafts in this IRC Master Control Kit handle from 70% to 87% of all control replacements. You pay only the regular net of \$14.97 (\$24.95 list) for the controls, switches and shafts. The All-Metal Cabinet is included at no extra cost!

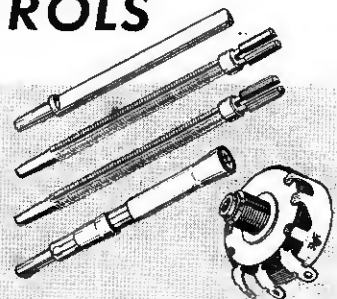

INTERNATIONAL RESISTANCE COMPANY, 401 NORTH BROAD STREET, PHILADELPHIA, PA.

RADIO RETAILING Combined with RADIO TODAY, April, 1942



10 and 20-watt fixed. Also adjustable up to 200-watt. All popular resistance values. Available in other mountings and terminals.

★ Those green-colored power resistors you now see in quality receivers, amplifiers, power packs, oscillographs, test instruments and other fine assemblies, are GREENOHMS. You'll also find them in radio transmitters, aircraft and police equipment and various electronic "rigs." GREENOHMS are chosen by builders of equipment that *must stand up*. Likewise they must be the logical choice for service jobs that *must not let you down*.

Ask Our Jobber . . .

★ Ask him to show you Greenohms. Examine these resistors critically—note neat inorganic-cement coating, smooth winding, positive-contact band, sturdy mounting feet, rugged terminals. Then try a Greenohm. Compare it with others. That's all we ask. Data on request.



CLAROSTAT MFG. CO., Inc.
285-7 N. 6th St., Brooklyn, N. Y.

Pick-up Compensation Circuit in Wilcox-Gay A-111, A-112

The crystal phono pick-up circuit in these radio recorder models is designed to improve the response and also act as a voltage divider for the high gain input tube. The 6J7 is used as both a microphone pre-amplifier and pick amplifier. Since the crystal mike requires much more amplification than the pick-up, the voltage divider is required to cut the pick-up output. In the accompanying circuit the divider system is shown.

In order to obtain desired frequency characteristics, the resistors of the voltage divider are bypassed with condensers. Since the crystal pick-up is a nearly constant voltage generator over practically its entire range, the output voltage which is applied to the grid of the 6J7 will depend upon the ratio of the impedances of the upper and lower sections of the voltage divider at various frequencies. The total impedance of the capacity shunted resistors drops rapidly with frequency and therefore, the 0.25 meg resistor in series with the combination begins to be an important part of the divider.

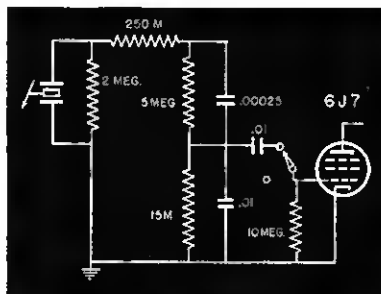

At 100 cycles the impedance of the 5 meg resistor and 0.00025 capacitor is about 3.9 megs, while the lower section of the divider remains at about 14,900 ohms. Adding the 0.25 meg series resistor gives a total impedance of about 4.1 megs. The ratio of the voltage across the lower section of the divider supplying the 6J7 grid to the output of the pickup is about 1:265. At 1000 cycles, this ratio is about 1:65, and at 10,000 cycles the ratio is 1:160. Thus the divider tends to equalize the characteristic rise in output of the pickup at the high frequency end of the range. Because the terminal impedance, or total impedance across the pickup, is high at the low frequency end of the audio range, the output of the pickup is higher and is thus equalized by the voltage divider which delivers only about one-quarter as much voltage to the amplifier at 100 cycles as at 1000 cycles.

Walsco Chemical Samples

A kit of nine sample chemical products of the W. L. Schott Co., Dept. 24, 5270 W. Pico Blvd., Los Angeles, Calif., has been prepared and is avail-

able free to manufacturers of radio and allied products, laboratories, government agencies, etc. Included in the kit are samples of radio-type cements including polysterene cement, thermoplastic cement, and others. A special contact cleaner for switches, volume controls, etc., is made from a new formula containing the correct amount of lubricant for best operation of the unit. A sample of Walsco-Lub B, lubricant for switches, etc., is included. A liquid anti-slip compound for dial belts is easy to apply and gives a lasting friction.

All chemicals are available in quantities from 2 oz. to 50 gallons.

Wartime Service Program Announced by Stromberg-Carlson

A special radio service program, announced by Stromberg-Carlson Mfg. Co., is designed to give the maximum promotional and technical aid to service departments for the "duration." Features of the new program include colorful display cards and window decals showing the S-C Wartime Radio Service seal. The technical helps include complete service data with schematics, wiring diagrams, voltage charts, alignment procedure, etc. Additional information will be made available at intervals through Wartime Radio bulletins. Dealers are being provided with copies of the Wartime Radio Service Policy booklet giving detail features of the plan.

Book Review

Defense Edition of Radio Amateur's Handbook

Published by The American Radio Relay League, West Hartford, Conn.

The wide use of the standard Amateur's Handbook in defense training radio classes has led to the publishing of a special edition designed for the purpose of serving as a text and reference book for radio classes.

This new 288-page edition contains fourteen chapters. Nine of the basic theoretical chapters of the standard handbook are retained intact, while additional chapters on fundamental mathematics, learning the code, and other useful data make the book more suitable for class instruction. The subject included in the nine chapters taken from the regular Handbook include among other things, electrical and radio fundamentals, vacuum tubes, wave propagation, antenna systems, measurements and equipment, workshop practice.

The price of the Defense Handbook, paper bound, is \$1.



**Can You Look?
Beyond
To-morrow!**

Far sighted Jobbers and service men realize the necessity of protecting the standing which they have built. They realize that Condenser replacements account for about 40% of all radio repair jobs and that dependable condensers are essential to the building of the utmost in customer satisfaction and in developing a growing clientele.

CONTINUOUS, DEPENDABLE SERVICE

For 21 years the manufacturers of POLYMET ELECTROLYTIC and BY-PASS CONDENSERS have striven to improve quality and service. Add to this a liberal and reasonable mark-up and the fact that no fly-by-night "bargain catalogs" can undersell you on POLYMET. You're protected, your customer is satisfied, your profits and volume increase. We're conserving vital defense materials by limiting sizes to those most universally used. These will serve practically every need, replacing larger electrolytics when proper capacity and voltage are used.

Complete listing of available types and prices will be forwarded upon request.



POLYMET CONDENSER CO.
699 E. 135th ST. NEW YORK, N. Y.

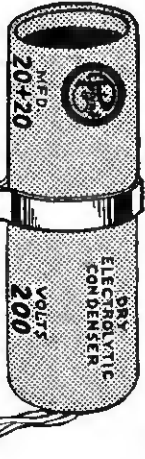

**A SPECIAL MESSAGE TO INDUSTRIES
CONVERTING TO WAR WORK**



... If you have any magnet wire or coil problems or need increased production on these items

Anaconda Can Help!...

WRITE US IMMEDIATELY FOR COMPLETE INFORMATION

ANACONDA WIRE & CABLE COMPANY. GENERAL OFFICES: 25 Broadway, New York. CHICAGO OFFICE: 20N. Wacker Drive. Subsidiary of Anaconda Copper Mining Company. Sales Offices in Principal Cities. 422622R



Magnet wire and coils

ANACONDA WIRE & CABLE COMPANY

WHY BUY A YACHT?

when a speedboat will do?

RCP Test Instruments are simplified, stripped of frills, to give you maximum sensitivity and flexibility in particular features and ranges. Buy the model which supplies the features you need; just what your work requires—nothing more! Compare RCP testers, analyzers and signal generators—point by point—with others at any price and see for yourself why RCP Test Instruments are among the biggest values

in radio! Send for Catalog No. 125. Look at RCP Model 702, Signal Generator—the most complete instrument for the modern laboratory or service shop. Direct reading. Range 95 Kc. to 100 Mc. Continuously variable. Portable counter case. Complete, only \$27.95. Available to radio men who are servicing priority plants and public institutions. See your distributor for details.



RADIO CITY PRODUCTS CO., INC.
88 PARK PL. • NEW YORK, N. Y.

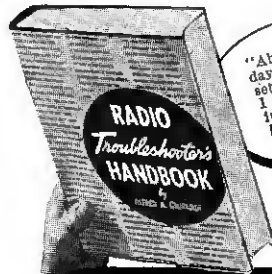

"Absolutely tops! First day it helped me repair 4 sets within 3 hours—sets I hadn't been able to fix in 2 days." — writes M. Penczak, a serviceman in Lawrence, Mass.

710 PAGES
new revised enlarged

The Biggest Help in Service Work Today!

why don't you too do every one of your servicing jobs faster? Get this help from this new 2nd edition of Ghirardi's

RADIO Troubleshooter's HANDBOOK

ARE YOU UP TO YOUR NECK IN SERVICE WORK NOW?

More and more alert servicemen all over the country are learning that they can't afford to be without Ghirardi's new, up-to-the-minute second edition of the RADIO TROUBLESHOOTER'S HANDBOOK for a single day. It speeds Troubleshooting . . . eliminates lost time hunting for Servicing Data . . . saves Repair Time. Contains the whole vast fund of factory-checked, working data every serviceman needs today . . . arranged for quick split-second reference.

"The information I received from Ghirardi's RADIO TROUBLESHOOTER'S HANDBOOK paid for the book at least THREE times over within four hours of the time the postman delivered it," writes C. Paul Luzon, a serviceman in Burlington, Vt.

"Saves loads of time, even if a shop has a complete set of service manuals" . . . writes W. Pooser Jr., a serviceman in Augusta, Ga. . . Yes, no matter how many service manuals you have, this new 710-page "Ghirardi" Handbook will give extra time-saving help. Now only \$5.

"BRUSH UP" ON THEORY TOO, AND MAKE MORE MONEY!

You can make more money in the Army or Navy . . . and win promotion faster. Just as in industry, by having fundamental radio theory at your finger-tips. "Brush up" Now, with Ghirardi's RADIO PHYSICS COURSE . . . contains 972 pages, over 500 photographs and diagrams, 856 special self-review questions to help you check every step of your rapid progress. And, for servicing use . . . the MODERN RADIO SERVICING . . . the 1300-page text containing 796 illust. and 720 review questions. Each is priced at only \$5.

SPECIAL MONEY-SAVING "COMBINATION" MODERN RADIO SERVICING PLUS TROUBLESHOOTER'S HANDBOOK—only \$9.50

New "REPLACEMENT BATTERY" Wall Chart Gives "Type" Numbers of all the "REPLACEMENT" A, B, and A-B Batteries for 1250 portable receiver models. Worth many dollars, this big 17" x 22" chart is yours for only 10c. Send for one today.

SEE GHIRARDI'S BOOKS AT YOUR LOCAL DEALER TODAY.

RADIO & TECHNICAL PUBLISHING CO.
Dep't. RRT 42 • 45 ASTOR PLACE, NEW YORK, N. Y.

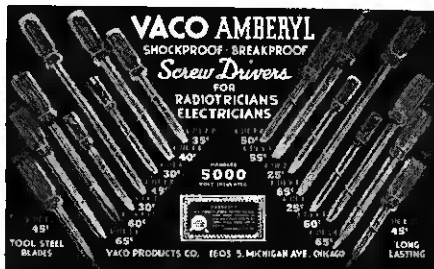

VACO RADIO DISPLAY UNIT IS

an example of our leadership in producing "the right driver for the right job." Me-

chanics and servicemen everywhere say: "Vaco's best!" 157 different types of screw drivers in the Vaco line covering every need and suited for every purpose. Handles of break-proof and shock-proof Amberyl. Inquiries invited.

VACO Products Co. 1603 S. Michigan Ave. CHICAGO, ILL.

Marine Corps Needs More Radio Men

The United States Marine Corps has issued a call for a large number of officers with electrical background, for supervising and maintaining its radio equipment. Civilians between 20 and 40 are urged to apply for commissions in the Corps, according to the Commandant Lieutenant General Thomas Holcomb.

Candidates for commissions should have training or experience in electrical engineering, radio, communications, or electronics. Those living in the Western Division comprising the states of Arizona, California, Colorado, Idaho, Nevada, New Mexico, Mon-



Big sound jobs are now being sold as part of the war program, and that's one reason why Hal Corry, left, a well known sales rep from Dallas, Tex., confers with Sidney Harman of the Bogen Co., at a meeting in New York City.

TWO IMPORTANT DATES



Two Weeks Apart

MOST IMPORTANT DATE IN THE HISTORY OF RADIO SERVICING

No new sets for the public means plenty of old ones for you. To your already heavy volume of repair work will now be added the rebuilding of millions of worn-out sets that ordinarily would be replaced by new ones. It is YOUR responsibility to "keep 'em playing." As many of these sets will be five, eight, ten years old, you need ALL THIRTEEN RIDER MANUALS.

Rider Manual Volume XIII was published on April 6th, just two weeks before the halt of new set production. Swamped with work—operating short-handed—forced to improvise on many jobs—established service shops MUST increase their efficiency if they are to continue to serve their public. So—order Volume XIII and any other volumes you need—today!

RIDER MANUAL VOL. XIII

JUST OUT — APRIL 6th
1672 Pages — Price \$11.00

Order Now — Avoid Disappointment

RIDER MANUALS

Volumes XIII to VII.....\$11.00 each
Volumes VI to III.....\$8.25 each
Abridged Volumes I to V.....\$12.50
Automatic Record Changers and Recorders.....\$6.00

FOR SPRING PUBLICATION

Inside the Vacuum Tube—complete elementary explanation of fundamentals of vacuum tubes. A-C Calculation Charts—146 charts covering A-C calculations from 10 cycles to 1000 mc.

OTHER RIDER BOOKS YOU NEED

The Cathode Ray Tube at Work.....\$3.00
Frequency Modulation.....1.50
Servicing by Signal Tracing.....3.00
Meter at Work.....1.50
Oscillator at Work.....2.00
Vacuum Tube Voltmeters.....2.00
AFC Systems.....1.25

HOURLY-A-DAY-WITH-RIDER SERIES—on "Alternating Currents in Radio Receivers"—on "Resonance & Alignment"—on "Automatic Vol. Control"—on "D-C Voltage Dist." 90c each

JOHN F. RIDER PUBLISHER, Inc.
404 Fourth Avenue New York City
EXPORT DIVISION: Roche-International Elec. Corp.,
100 Varick Street, New York City. Cable: ARLAB

tana, Oregon, Utah, Washington and Wyoming are advised to write to Lieutenant Colonel Raymond W. Conroy, Naval Reserve Aviation Base, Oakland Airport, Oakland, California, or The Commandant, U. S. Marine Corps, Headquarters, Washington, D. C.

Moss Leaves NRPDA in Strong Position

Arthur Moss, the widely known executive secretary of the National Radio Parts Distributors Association, has resigned that position, according to news from the office of the NRPDA president, George D. Barbey, Reading, Pa. Mr. Moss has received a promotion in his position with the Pollack Co., and has been transferred to Groton, Conn.

As the directors and officers of NRPDA reluctantly accepted the resignation of Mr. Moss, it was pointed out that when he started work with the organization it had less than 100 members and a deficit of over \$1,000; NRPDA now has 248 members and about \$3,000 in the treasury, with 12 districts in active operation.

Temporary headquarters of the NRPDA have been set up at Mr. Barbey's offices at P. O. Box 2, Reading, Pa. He has personally handled the business of the association in New York and Washington contacts, while William Schoning of Chicago has done the work in that area.

Although the annual Radio Parts Show in Chicago has been called off for the duration, efforts are being made to get the NRPDA jobbers together anyway. It is pointed out that wartime conditions demand a strong jobber organization, and that a large number of active district chapters are especially important now.

Fogel to New Home

Mortimer H. Fogel, prominent New York City dealer, has moved his store to enlarged and improved quarters at 92 Liberty St. The organization has for many years been known as "The Friendly Store" and handles complete stocks of radios, combinations, records, cameras and photo supplies, and electrical appliances.

YOU NEED RIDER MANUALS TO "CARRY ON"



Admiral Offers \$500 for New Product Idea

An offer of \$500 cash is being made to the radio man who will make the best suggestion as to a product suitable for wartime manufacture and sale, by the Continental Radio & Television Corp., 3800 Cortland St., Chicago, Ill. The awards were announced by Ross D. Siragusa, Admiral president.

Admiral already has two plants converted to war production, but has a third factory which will be ready to turn out a new product essential to civilians. The firm invites dealers to send in rough ideas for such a product, and it will be sole judge of the merit of the suggestions.

Requirements are that the product not be made of materials essential to the war effort; it should be essential and worthwhile, rather than of a novelty nature; it should be something that the dealer will be able to sell. It does not need to be entirely new; a real improvement of a widely accepted product may be the winner.

Detrola Names Chief Engineer

The appointment of Roger M. Daugherty as vice president and chief engineer of the newly created defense division of the Detrola Corp., Detroit, has been announced by the Detrola president, John J. Ross. Mr. Dougherty has had 17 years of technical radio experience, and was previously connected with the engineering staff of the Crosley Corp.

In its defense division, Detrola now has more than \$1,000,000 worth of war contracts in work progress.

New Headquarters for National Union

Increased production at National Union Radio Corp., Newark, N. J., is the reason for the firm's announcement of new headquarters at 15 Washington St., Newark. The company has leased the entire 10th floor of the new building and will transfer its executive, sales and accounting divisions there. National Union products include receiving tubes, transmitting tubes, panel lamps, cathode ray tubes, condensers, etc.

Newspaper Mats Free to Servicemen

Hygrade Sylvania Corp. has released a new series of 1 and 2 column newspaper mats, available free to Sylvania radio servicemen. "Radios Need Inspection Too" is one of the themes illustrated in humorous style; others are handled in radio quiz form, telephone dial, dramatization of late news bulletin reception, etc.

Sylvania urges radio servicemen "to promote their expert abilities aggressively, right now when new sets are

disappearing from the market and the public can keep up their 'radio contacts' only by having a serviceman repair broken down sets."

Coons Adds to Staff

Sheldon R. Coons, general business counsel in management, merchandising and advertising, 113 W. 57th St., New York, N. Y., announces that Robert H. Leding, regional business consultant of the United States Department of Commerce, has resigned from that position to join Mr. Coons' staff.

Prior to his post as liaison officer for the Department of Commerce, Mr. Leding was for fifteen years manager of marketing and research of the New York office of Lord and Thomas, advertising agency.

Mr. Coons set up his new service a year ago, after announcing his retirement from the agency field. He is counselling several leading industrial firms. In his association with Mr. Coons, Mr. Leding will interest himself particularly in problems of the war and in direct planning for the post-war period.

Why Waste Time!



#14-1026—Adjustable Antenna Coil



#14-1027—Adjustable R. F. Coil



#14-1028—Adjustable Oscillator Coil

No need to waste your valuable time waiting to obtain an exact duplicate of Antenna, R. F. or Oscillator Coils when you can replace with the Meissner Universal adjustable coils. They will replace the broadcast band coils in practically any receiver in use today.

Adjustable Ferrocarril iron core used in these coils add gain and selectivity to the receiver. Continuously variable in inductance over a wide range, these coils will "track" with other coils in the receiver after a simple screw driver adjustment.

In stock at all Meissner jobbers . . . Net Price 83 cents each. Try them on your next coil replacement job.

GET YOUR COPY TODAY!

The best quarter investment you ever made. Meissner's I.F. Transformer Replacement Manual. Lists replacement I.F. Transformers for practically all models of radios since the advent of super-hets . . . only 25 cents at your Meissner distributor.



WRITE FOR COMPLETE NEW CATALOG ADDRESS DEPT. RT. 4



Meissner
MT. CARMEL, ILLINOIS
"PRECISION-BUILT PRODUCTS"



Today, It's More Vital Than Ever— TO STOCK THE TUBES THAT MOVE!



★ TANKS NEED TUBES!

★ PLANES NEED TUBES!

★ SHIPS NEED TUBES!

and
★ AMERICA NEEDS TUBES!



PREFERRED TYPE RENEWAL TUBES PROGRAM

TUBES that “gather dust” on your shelves for months on end can no longer be tolerated. Such tubes not only eat up your profits in overhead . . . *they tie up vital defense materials!*

Of more than 500-odd tube types, just 66 account for 71% of *all* American renewal tube demand . . . and up to 84% by “interchanging” types. With tube availabilities limited by America’s wartime needs—and with radio today more important than ever—tubes belong in radio *sockets*. The

RCA Preferred Type Renewal Tubes Guide helps you to put them there quickly—with minimum time between factory and user.

For, at a glance, your Guide tells you not only *which* tubes to stock, but *how many of each*, as well. It enables you to set up a “model stock” that is matched to normal demand . . . based on facts, not theory.

Ask your RCA Tube and Equipment Distributor for *your* copy, today!

Remember Pearl Harbor!
BUY U.S. DEFENSE BONDS



Radio Tubes



RADIO GOES ALL-OUT FOR WAR

(Continued from page 17)

provision of allowing dealers and distributors to exchange tubes on a numerical basis, instead of limiting exchanges to identical types, was expected to make for greater flexibility in enabling trade channels to simplify their stocks and reshape them to meet the widest needs.

Simplification of radio tubes which now number 712 types, and elimination of obsolete and little-used types may be accomplished soon under the pressure of war. An order is understood to be now drafted by the WPB calling for the elimination of nearly 400 types of radio tubes. When this WPB order is put into effect there will be about 300 remaining types of active tubes. From this number, tube manufacturers will then be invited to make recommendation for further deletions, combinations and substitute arrangements, possibly using converting sockets or calling for rewiring of sets to take the new substitute tubes. In this way the total tube types remaining may be reduced to 150.

\$125,000,000 Per Month

As the radio-set factories go onto a war basis, production of communication equipment needed by the military services is expected to exceed a rate of \$125,000,000 a month by the end of 1942.

The program for this type of war material—including that delivered, on order, and yet to be allocated—amounts to approximately \$2,000,000,000. About half of the program is for detector equipment; 20 per cent for aircraft and navigation equipment; 20 per cent for tank sets; walkie-talkies, etc.; and the remainder for telegraph, telephone, and miscellaneous equipment. About 120 set models are included, ranging in cost from \$75 to \$85,000 a unit, each made according to the most rigid specifications of the Army and Navy.

Of the 55 manufacturers of civilian radio receiving sets, 21 had experience last year making military equipment worth \$10,000,000. Contracts worth \$500,000,000 have been awarded to set manufacturers so far this year, with about 40 firms sharing the orders.

Most of the volume, however, has gone to a few companies, and only eleven companies have booked war business in excess of their 1941 ci-

vilian business. That leaves a lot of facility yet to be used for military communication equipment. This will come from plants now holding only small orders and from plants that now are doing no war work. It is expected, however, that a few of the plants that will stop making civilian sets will not get orders to build communication equipment. These plants, with limited technical facilities, probably will turn to assembling, if they are to continue operation. Typical of the kind of work they may find to do is that of assem-

bling gas masks, machine gun clips, first-aid kits, etc. Some of the radio cabinet makers already affected by the curtailment order have used their ingenuity to get orders for making tool kits, medicine cabinets and other articles requiring skill in wood work.

Andrea Radio Expansion

New and larger quarters have been occupied by Andrea Radio Corp., the Long Island City, N. Y., radio manufacturing firm headed by F. A. D. Andrea. The company's new home is located at 43-20 34th St.

READY to meet the greater responsibilities that face electrical instruments today, is the basic superiority that skyrocketed Simpson Instruments to the top in just a few years.

If the part you play in America's arming calls for electrical instruments, call for Simpson.

SIMPSON ELECTRIC COMPANY
5208-18 W. Kinzie Street, Chicago, Illinois

Simpson
INSTRUMENTS THAT STAY ACCURATE



"REPLACEMENT" FAVORITE

for Public Address, Inter-Communicating Systems and Recorder Sets



● Because of their high efficiency, practicality and relatively low cost, Astatic JT-Series Crystal Microphones are widely used and highly recommended for replacement installations. JT-Series Microphones are made in both voice and wide range models and come completely equipped with concentric cable connector, convenient wood handle, interlocking metal base and 15-ft. cable.

These models may be used for either desk or hand microphones or, with handle removed, on floor stand. Two tone finish.

SEE YOUR RADIO PARTS JOBBER



THE ASTATIC CORPORATION

YOUNGSTOWN, OHIO

Licensed Under Brush Development Co. Patents

In Canada: Canadian Astatic Ltd. Toronto, Ontario

Come and get it...or send a

Fidelitone

PHONOGRAPH NEEDLE

Its Platinum Metals Point gives over 1000 perfect plays with Natural Tone Quality. Filters Record Scratch. Saves your records. All for 50¢. Permo Products Corp., Chicago.

PERMO Pivot Points AID NATIONAL DEFENSE IN Ship Compasses

As Advertised in . . . the Ladies Home Journal and 10 other magazines

SPECIFY DEPENDABLE "SMOOTH POWER" UNITS

OUTSTANDING G. I. leadership—for years back—not only has developed and produced better phonograph motors, record changers and home recorders, but makes them available today in dependable G. I. "Smooth Power" units. Despite shortages of materials . . . despite prompt and effective G. I. participation in America's powerful industrial war effort . . . leading distributors have G. I. equipment for commercial demand. Consult your jobber. For handy catalog and price sheet, please write us.



Phonograph Motors Home Recorders Record Changers

The GENERAL INDUSTRIES CO. DEPT. 15

ELYRIA, OHIO

RECORD NEWS

(Continued from page 24)

25 old records plus 29c gets one new 12 in. Black Label or one 10 in. Victor Red Seal
35 old records plus 35c gets one new 12 in. Red Seal

New Southern Slav Album Released by Sonart

The talents of Rasha and Mirko, baritone star and guitar virtuoso, are well displayed in a new album (M1) of three 10-inch double faced discs just announced by Sonart Record Co., 251 W. 42nd St., New York, N. Y.

Entitled, Songs of the Southern Slavs, this new album, like its fore-runner South Slav Melodies, features the colorful tunes of the Slavic nations. Typical national tunes are sung and played by the two artists, Rasha and Mirko who were first introduced to the American audience at the New York World's Fair.

The album has photographs of the two artists with a brief story of their careers. The story (in English) of each of the Slavic songs is included.

Tommy Dorsey Signs Again with Victor

Tommy Dorsey has signed a new long term contract with RCA Victor, and thus begins his 7th year as an exclusive recording artist with the company. This action puts an end to the rumor that Mr. Dorsey would make records for a new record outfit to be organized by Metro-Goldwyn-Meyer.

The famous bandleader now has a Sunday night network show on NBC, and will replace Red Skelton on Tuesdays starting June 16, for the summer period. Mr. Dorsey's new movie, "Ship Ahoy" will be released shortly, and another picture is being planned.

Western Fall Market in August

Dates for the 1942 Western Fall Market, San Francisco, have been set for Aug. 3rd to 8th, according to news from the Western Merchandise Mart. This event will include showings of furniture, floor coverings, appliances, gifts and housewares, etc., and will be of special interest to radio men looking for "substitute" lines.

Technical Translations

An announcement from Uiplano Munic, Cuban linguist whose address is now P.O. Box 42, Antilla, Oriente, Cuba, reveals that he will shortly move to New York City. Mr. Muniz and associates operate a "technical translations" service in all languages.



Pennsylvania Radio Men Feted

Radio servicemen, amateurs, and staff men of station WBAX got together for a lively meeting recently when Edward Nowicki, owner of Voss Sales Co., Nanticoke, Pa., was host to the Radio Servicemen's Association of Luzerne County, Pa., at the Quoit Club Rooms, Nanticoke.

C. Foster Hick as master of ceremonies introduced the RSA officers, including Edward Buckman, president; J. Austin Renville, vice-president; John Kennedy, treasurer; Walter Neeld, secretary; also the Board of Directors, Mr. Hick, Dan Davis, Edward Tischler, Spencer Eddy, Pat Maneval and Mr. Nowicki.

Ralph Brown introduced the "hams" to the servicemen, and another feature of the evening was the presentation to John H. "Pop" Stenger Sr. of WBAX of a gift from RSA, in recognition of Mr. Stenger's service to radio in the area. Celebrities were asked to address the group, and later entertainment included motion pictures shown by City Radio Service of Wilkes-Barre.

Guests were, besides those mentioned above: George Van Kirk, John H. Sterger, Jr., Gordon Shook, Homer Danner, H. A. Seville, D. Walter Jones, Barney Warner, Wm. L. Roberts, Fred J. Alles, Frank Drelstadt, C. F. Bogdan, Jack Titus, Britton McLaughlin, Milan Krupa, Peter Konnick, Robert Stiger, J. R. Jackson, Ben Howells, Frank Kiehar, Edward Groszanski, John Beeuna, Joseph Petrosky, Edward Javis, R. F. Smith, Adam Kalinoski, Joseph Munchberg, Joseph Jablonski, Stanley Panizak, Ignatius Drungell, Stanley Jaricki, Paul Biniek, Max Frederick, Joseph Sincavage, Al Masteroff, Walter Horonzy, Stanley Blaschak, Joan Pavolonis, William Hellenbrand, Leonard Tumbolo, Frank Kubasko, Joseph Kawowski, Michael Kulka, Thomas Lewis, Chester Ratoski and Joseph Chesluk.

Bell Sound Hikes Production

In response to the new demand for industrial paging systems, intercommunications systems and various special equipment for the Army and Navy departments, it has been announced by Floyd W. Bell, president of Bell Sound Systems, Inc., 1183 Essex Ave., Columbus, Ohio, that his company is now completing a plant addition which will approximately double the Bell production capacity.

In addition to its peak war effort the company emphasizes maximum cooperation to jobbers and dealers to aid them in meeting some non-defense requirements of their regular customers.

Cinaudagraph to Larger Quarters

Cinaudagraph Speakers, Inc. have moved all their office, machinery, and equipment to their new factory building at 3911-3929 South Michigan Ave., Chicago, according to news from Paul Tartak, president. This move provides additional floor space for production of radio and electrical equipment for the Signal Corps and other branches of the government.

A Chance for Jobbers and Servicemen to

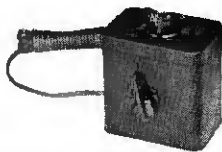

RAID-O-LARM ADAPTER V model! \$5⁰⁰

("V" for Victory.)

Introducing a smaller model of RAID-O-LARM Adapter . . . a home owner's set version of the large type
(SENIOR, listing at \$8.50)

SENIOR is still retained in the line for big jobs—more particularly institutional and industrial use, whereas "V" does a man's size job in the home; all that is required for the average household.

Its introduction NOW in the line widens the selling opportunity for servicemen and jobbers alike.

Both models are capably engineered . . . both responsibly engineered and built for critical service with the full realization that the safety of an individual (or many) may depend on its operation.

A Statement

To All Who Made Inquiry About

BLACKOUT-ER

the new Radio-Remote-Control Unit for turning off lights of every description—indoors, outdoors, fixed or mobile—instantly and automatically following the broadcast of an official air raid warning.

Because of an overwhelming demand for information, demonstrations and deliveries, it will be necessary for us to re-GEAR, entailing a slight delay.

To all who made inquiry, we say—"Thank you, sincerely." We are digging out. A little patience and we will have news for you.

CLEAN UP!

—with the sensational new

RAID-O-LARM ADAPTER

Attached to any radio set, it sounds an alarm the instant a broadcast station transmits a warning and goes off the air

RAID-O-LARM is a scientific but simple instrument offered to the trade as an adapter. It can be quickly attached to any radio set, by any serviceman.

Requiring only a minimum of time for installation, it is a profitable item for the serviceman and its sales possibilities are unlimited.

The demand has far surpassed our expectations. It is plain that before long, the full tide of this demand will tax our facilities to the limit, particularly with the introduction of a new model listing at Five Dollars.

Therefore we urge jobbers and servicemen: Be patient in the matter of shipment but get your orders in as quickly as possible. If you need further information, write TODAY. Then, lose no time in letting us know your requirements.

BLACKOUT CONTROL Incorporated

CHRYSLER BUILDING NEW YORK

Expediter BOGEN!

BOGEN SOUND SYSTEMS are expediting production in key defense plants throughout the country.

INTERCOMMUNICATION between vital points is achieved instantly. Important messages to the workers are made while work continues. Alarms are sent automatically—in an instant—to every corner of the plant.

BOGEN SOUND SYSTEMS step up production—multiply efficiency—expedite the flow of work—Write for details!

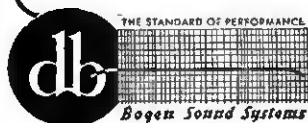

DAVID BOGEN CO., Inc.
663 Broadway, New York City

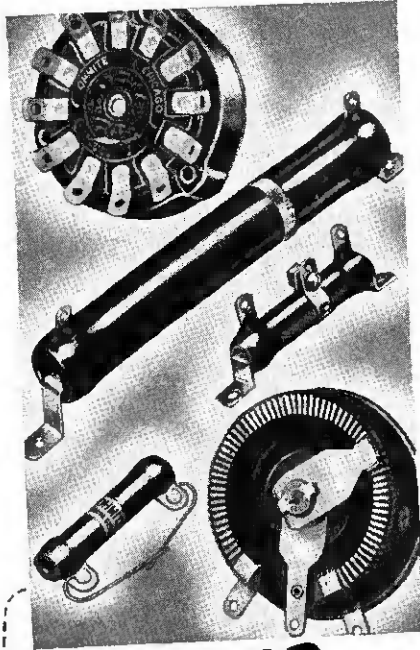

LONGER LIFE!

For Essential Equipment when

you use **OHMITE** Resistance Units

Life-savers—that's what you need in vital replacements today—and that's what you get in Ohmite Resistors, Rheostats, Chokes and Tap Switches. Their service-record on land, sea and in the air proves it. The wide range of types and sizes makes it easier for you to obtain what you need. Let Ohmite Jobbers help you.

Send for Handy Ohm's Law Calculator



Solves any Ohm's Law problem with one setting of the slide. Requires no slide rule knowledge. Size 4 1/8" x 9". Yours for only 10c to cover handling cost.

At Your Jobber or Send Coupon

OHMITE MANUFACTURING CO.
4871 Flournoy St., Chicago, U.S.A.

Send Free Catalog 18.
 10c enclosed—Send Ohm's Law Calculator.

Name

Address

City State

RR-April '42

Be Right with OHMITE
RHEOSTATS • RESISTORS • TAP SWITCHES

Michigan NRPDA Holds Lively Meeting

One of the steps taken at the latest meeting of the Michigan chapter of the National Radio Parts Distributors Association, at the Detroit Leland Hotel, was a vote of honor for Arthur Moss, the recently resigned executive secretary of NRPDA. A resolution cited "the fine work done by Mr. Moss for the Association."

The jobbers also discussed means for getting definite action on the matter of supplies for the service trade, in an effort to help national welfare by keeping at least one set in every American home in operation. Priorities were delved into, with a view of the jobbers cooperating with each other, with the manufacturers, and with OPM to the greatest and most efficient degree possible.

At the meeting were the following Michigan distributors: Gordon Fulton, Fulton Radio Supply, Jackson; C. E. Philpot, Radio Tube Merchandising Co., Flint; Ed Shand, Shand Radio Specialties, Flint; Al Lifsey, Lifsey Distributing Co., Flint; Harold King, Wholesale Radio Supply, Pontiac; Al & Ted Rissi, Rissi Bros., Detroit & Grand Rapids; Carl Pusch and Molly Williams, Radio Specialties Co., Detroit; and George Wedemeyer, Wedemeyer Radio Co., Ann Arbor, Battle Creek & Kalamazoo.

Two IRC Execs Promoted

Further expansion in the facilities of International Resistance Co., 401 N. Broad St., Philadelphia, has resulted in two new promotions and one addition to the IRC staff, according to news from IRC president Ernest Searing.

Harold G. Beebe, formerly the assistant manager of the IRC industrial division, is now manager; Harry A. Ehle, who was previously the manager, becomes vice-president of the company. Robert Elmore, a newcomer to IRC, will assist Mr. Beebe.

Rep Announces Extra Services

Announcements from Detsch & Co., manufacturers representatives with main offices at 341 Tenth St., San Francisco, Calif., say that the firm is now prepared to do extra sales work for eastern manufacturers who want to concentrate on their wartime production problems. The Detsch service includes issuing reports, quotations, circulars, etc., in the territory covered by the company—all areas west of Colorado's eastern boundary. Detsch now sells to 500 jobbing accounts in varied fields, as "Managers Western Sales Office of Eastern Manufacturers."

University

For "SOUND" Air Raid Protection Every BUSY City should have complete ALARM and VOICE coverage with UNIVERSITY REFLEX SPEAKERS

Reflex Speaker Air Raid Alarm System has as many advantages over the "pure" siren as the modern intercommunicator has over the obsolete call bell system. Reflex Speakers eliminate confusion in black-outs and definite orders can be issued direct to the air raid warden and civilian population. Reflex Speakers prevent panic—a few reassuring words that the situation is well in hand may prevent needless loss of life. Cities already equipped with air raid sirens must have additional speaker systems in crowded sections to direct and control motorists and pedestrians.

UNIVERSITY LABS., 195 Chrystie St., NYC

HOW TO CUT HOLES IN RADIO CHASSIS THE EASY WAY

NO FILING . . .
REAMING . . .
OR TEDIOUS DRILLING

With the Greenlee Radio Chassis Punch, the radio worker can save hours of work when cutting holes for sockets, plugs, connectors, meters, and other receptacles in radio chassis. A cap screw is inserted in a small drilled hole, and the punch is easily forced into the die by a few turns of the screw with an ordinary wrench. These punches are available for cutting 3/4 to 2 1/4-inch holes. A Greenlee Knockout Cutter is also available for cutting holes up to 3 1/2-inch size. Send for new circular S-114 on Radio Chassis Punches.

GREENLEE TOOL CO.
1904 Columbia Ave. Rockford, Ill.



Promoting Appliances Already Sold

"How to get the most out of the appliances you now own" is the general theme now used by General Electric in its new advertising. Ads on this are scheduled to run during April and May in national magazines, according to news from the GE appliance and merchandising advertising head, Glenn Gundell.

Included in the ads is an offer of \$5 in defense stamps for each helpful hint accepted and published by GE—hints from housewives on how to save pennies and minutes with the appliances they now have. GE also offers to send, for 3c per copy, a new nutrition booklet "How to Get the Most Out of the Foods You Buy."

Radio Inspectors Needed by U. S.

Announcement from Washington is that "the position of radio inspector in the Federal Communications Commission has been added to those jobs in the field of radio for which the U. S. Civil Service Commission is seeking qualified persons. Salaries range from \$2,000 to \$2,600 a year. The maximum age is 45 years. Applications for the written test on radio and electrical engineering must be filed with the Commission's Washington, D. C., office not later than April 21, 1942."

Emerson Gets New Army Job

A new type of radio transmitter-receiver unit, previously used in Europe but never introduced here, will now be made for the U. S. Army Signal Corps by the Emerson Radio & Phonograph Corp. President Ben Abrams announced the Army contract, and said that it follows another defense order which Emerson had completed ahead of time.

Lasure Heads Booster Club

The Radio Booster Club of Southern California has elected a new president—Harry A. Lasure, pioneer manufacturers' agent of 2116 W. 11th St., Los Angeles, Calif. Don Wallace is the new vice-president and Herb Becker is secretary-treasurer. The Booster Club has been meeting monthly for over ten years.

NEWA Convention

The Thirty-fourth Annual Convention of the National Electrical Wholesalers Association will be held at The Homestead, Hot Springs, Virginia, May 17-20, 1942, according to an announcement from NEWA headquarters.

THORDARSON
Quality Transformers

A COMPLETE SELECTION OF FILAMENT, POWER AND AUDIO TRANSFORMERS FOR EVERY APPLICATION.

TRANSFORMERS FOR ALL USES. ASK FOR FREE CATALOG NO. 400 F. X.

• Engineering skill, care and precision are built into the many types of Transformers manufactured by... THORDARSON — Transformer Specialists Since 1895.

Any size—any type
 any quantity
 but only ONE quality

Thordarson Quality!

Consult us regarding your War Production Problems.

500 WEST HURON STREET • CHICAGO, ILLINOIS, U. S. A.

KEEP A BALANCED TUBE STOCK ALWAYS ON HAND



Win Customer Goodwill
 With Quick Service

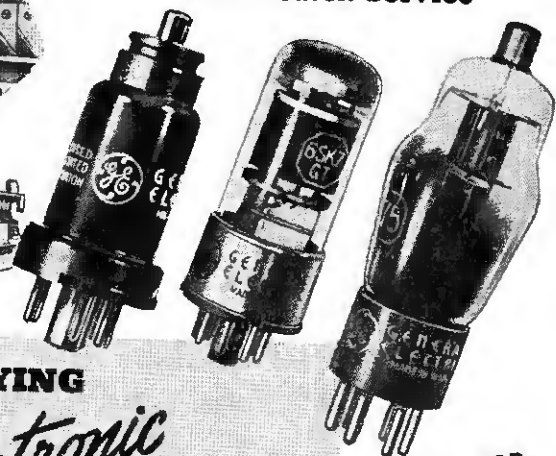

KEEP 'EM PLAYING



Electronic

RADIO TUBES

FAMOUS FOR
 LONG LIFE AND
 FINE RECEPTION

GENERAL ELECTRIC



• Yes, that's the story of Aerovox PBS cardboard-case dry electrolytics. Like-wise adjustable metal mounting flanges; polarity-indicating colored leads; generous voltage ratings; full capacity—these and other features brand them as ideal electrolytics when pennies count—and when radio-service reputation is at stake.

- Type PBS600—600 v. D.C.W. Single Section: 4 and 8 mfd.
- Type PBS450—450 v. D.C.W. Single Section: 2 to 16 mfd. Double Section: 4-4 to 8-16 mfd. Triple Section: 8-8-8 mfd.
- Type PBS250—250 v. D.C.W. Single Section: 2 to 30 mfd. Double Section: 4-4 to 16-16 mfd. Triple Section: 8-8-8 to 8-8-16 mfd.
- Type PBS100—100 v. D.C.W. Single Section: 5 and 10 mfd.
- Type PBS50—50 v. D.C.W. Single Section: 5, 10 and 25 mfd.
- Type PBS25—25 v. D.C.W. Single Section: 5, 10 and 25 mfd.

• Ask Our Jobber . . .

He'll gladly supply you with these Aerovox money-saving PBS electrolytics he stocks for your constant convenience. Ask for latest Aerovox catalog—or write us direct.



GE Gives Prizes for Ideas

Four prizes have been awarded to retailers who have submitted to the sales education section of the General Electric Co. appliance and merchandise dept., Bridgeport, Conn., winning letters on the subject of retail management under current conditions.

The following dealers were awarded a GE clock-barometer set: J. F. McAllister, Utah Power & Light Co., Salt Lake City; N. E. Kleckner, Stauffer Co., Minneapolis; David Echil, Echil-Kahn Co., Philadelphia; and Hilbert T. Forsberg, Forsberg Elec. Co., Brockton, Mass.

Technical Appliance in Expansion

Technical Appliance Corp. has expanded into new and larger quarters at 516 W. 34th St., New York City, with nearly three times the floor space of that at the former location on 16th Street. The new quarters provide new facilities for defense orders and other business, while additional equipment and personnel will make it possible to consider additional contracts heretofore turned down because of overloaded facilities.

Battery Merchandiser Cabinet

A new display cabinet for flashlight batteries, designed for "volume sales at minimum expense" is forthcoming from Bond Electric Corp., Division of Western Cartridge Co., New Haven, Conn. It's a compact displayer in red, blue and yellow, holding 36 batteries. There is an eye-catching cartoon theme (the same as used in Bond national ads) and a transparent cover to guard against theft.

The cabinet comes free with No. 96 Merchandiser Unit containing 96 batteries.

Radio Club of America Names Paul Ware

The Radio Club of America, an organization started in 1909, has elected from among its members a veteran radio amateur and professional, Paul Ware, to lead club activities this year. Since 1939 Mr. Ware has been associated with Allen B. Du Mont Labs., Inc., Passaic, N. J., working on various engineering and production problems.

Panoramic Moves

The Panoramic Radio Corp., makers of special radio equipment, have occupied new headquarters at 242-250 W. 55th St., New York City.



• These are LITTELFUSE FACTORS—not "equivalents." It is the LITTELFUSE Twisted Element that protects against severe vibration—the LITTELFUSE Locked Cap Assembly that holds caps firmly under all conditions—the LITTELFUSE Gooseneck that takes up contraction and expansion.



• Mechanical Strength, Fatigue Resistance, and Long Vibration Life are LITTELFUSE qualities accounted for by its scientific structure. It will pay you to familiarize yourself on the details of difference among fuses. Send for the complete Littelfuse Catalog, listing fuses and mountings for every instrument service.



LITTELFUSE, INC. 4791 Ravenswood Ave. Chicago, Ill.

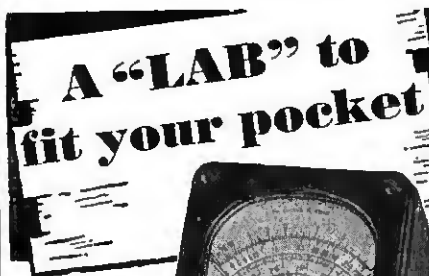

Readrite RANGER

MODEL 739

\$10.89 Dealer Net Price



A.C. D.C. VOLT-OHM-MILLIAMMETER

Pocket Volt - Ohm - Milliammeter with Selector Switch Milled Case. . . . Precision 3-inch Meter with 2 Genuine Sapphire Jewel Bearings. AC and DC Volts 0-15-150-750-1500; DC MA. 0-1, 1.5-15-150; High and Low Ohm Scales. Dealer Net Price, including all accessories, \$10.89 MODEL 739 . . . DC Pocket Volt-Ohm-Milliammeter. Dealer Net Price . . . \$8.25

WRITE FOR CATALOG

SECTION 1120 COLLEGE DRIVE

READRITE METER WORKS, Bluffton, Ohio



INDEX

To Advertisers

	Page
AEROVOX CORP.	46
ALLIANCE MFG. CO.	24
ANACONDA WIRE & CABLE CO.	37
ASTATIC CORPORATION	42
BITTER CONSTRUCTION CORP., A.	24
BLACKOUT CONTROL, INC.	43
BOGEN CO., INC., DAVID	43
CENTRALAB	5
CLAROSTAT MFG. CO., INC.	36
CONTINENTAL RADIO & TELEV. CORP.	1
GALVIN MFG. CORP.	Cover 4
GENERAL ELECTRIC CO.	45
GENERAL INDUSTRIES CO.	42
GREENLEE TOOL CO.	44
HYGRADE SYLVANIA CORP.	2
INSULINE CORP. OF AMERICA	48
INTERNATIONAL RESISTANCE CO.	35
KEN-RAD TUBE & LAMP CORP.	7
LITTELFUSE, INC.	46
MALLORY & CO., INC., P. R.	Cover 2, 33
MCGRAW-HILL BOOK CO.	48
MEISSNER MFG. CO.	39
NATIONAL UNION RADIO CORP.	47
NORGE DIV., BORG-WARNER CORP.	21
OHMITE MFG. CO.	44
PERMO PRODUCTS CORP.	42
POLYMET CONDENSER CO.	37
PRESTO RECORDING CORP.	23
RADIO CITY PRODUCTS CO., INC.	37
RADIO CORPORATION OF AMERICA ..	Cover 3
RADIO & TECH. PUBLISHING CO.	37
RAYTHEON PRODUCTION CORP.	9
RCA MFG. CO., INC.	3, 40
READRITE METER WORKS	46
RIDER, JOHN F.	38
SIMPSON ELECTRIC CO.	41
STROMBERG-CARLSON TELE. MFG. CORP.	10
THORDARSON ELEC. MFG. CO.	45
TRIPLETT ELEC. INSTRUMENT CO.	4
UNITED STATES TREASURY DEPT.	8
UNITED STATES NAVY	6
UNIVERSITY LABORATORIES	44
UTAH RADIO PRODUCTS CO.	25
VACO PRODUCTS CO.	37
WILCOX-GAY CORP.	19

While every precaution is taken to insure accuracy, we cannot guarantee against the possibility of an occasional change or omission in the preparation of this index.

Merchandising Head



James H. Carmine has been boosted to the post of vice-president in charge of merchandising for Philco Corp. He's been with the firm since 1923, and last year was made general sales manager.

NEW BOOKLETS

"GE Fluorescent Accessories" is the title of a new folder which describes and illustrates starters, lampholders, starter sockets and control switches. Available on request from General Elec. Co., Appl. & Mdse. Dept., Bridgeport, Conn.

Kato Engineering Co. of Mankato, Minn., have released a new circular "Electrify with Katolight," giving specifications and illustrations of their power plant, model 51A.

IRC resistor guide, giving essential data on over 122 sizes in 18 standard types of fixed and variable resistors for defense and industrial requirements, will be sent on request. International Resistance Co., 401 N. Broad St., Philadelphia, Pa.

Precision Tube Co., 3824 Terrace St., Philadelphia, Pa., have released a new bulletin No. 201, free of charge, which gives complete mechanical and electrical specifications of Packard Elec. Wire, also capacities and power factors of metal shielded wire.

A 32-page catalog PS-405 presents the complete line of UTC transformers for broadcast, amateur, laboratory and replacement purposes. United Transformer Co., 150 Varick St., New York, N. Y.

Acro Electric Co., 3173 Fulton Road, Cleveland, Ohio, have released a condensed catalog giving illustrations, diagrams, specifications and engineering data, on their line of Acro-Snap switches for precision control.



MR. JOHN GEO. COLEMAN
Radio Maintenance of Westchester
110 Mt. Vernon Ave., Mt. Vernon, N.Y.

"N.U. products have always been of the highest quality. The N.U. plan has helped me get those much needed pieces of testing equipment."

WHERE YOU FIND
NATIONAL UNION
YOU FIND BETTER
RADIO SERVICE

PREMIUM
Quality
TUBES



BATTERIES



CONDENSERS

also Transmitting tubes, panel lamps, cathode ray tubes, exciter lamps, sound equipment, photo electric cells, sound accessories, dry batteries, flash light bulbs.

NATIONAL UNION invites . . .

All radio service dealers to enjoy the benefits of the N. U. Shop Equipment Plan. The latest in tube testers and test equipment are available to you . . . prompt delivery. More than 60,000 completed deals prove the success of this plan. Investigate now.

Ask Your N. U. Distributor or Write



NATIONAL UNION
RADIO Corp.
57 STATE ST., NEWARK, N. J.



NOW
a really high-powered
**RADIO
ENGINEERING
LIBRARY**

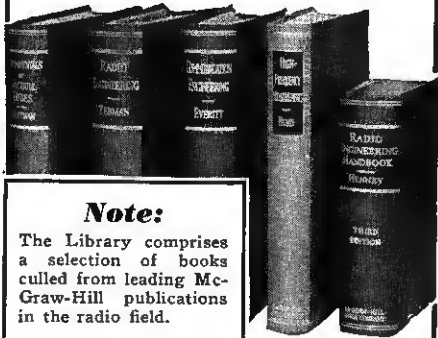

Note:
The Library comprises a selection of books culled from leading McGraw-Hill publications in the radio field.

- ▶ especially selected by radio specialists of McGraw-Hill publications
- ▶ to give most complete, dependable coverage of facts needed by all whose fields are grounded on radio fundamentals
- ▶ available at a special price and terms

These books cover circuit phenomena, tube theory, networks, measurements, and other subjects—give specialized treatments of all fields of practical design and application. They are books of recognized position in the literature—books you will refer to and be referred to often. If you are a practical designer, researcher or engineer in any field based on radio, you want these books for the help they give in hundreds of problems throughout the whole field of radio engineering.

5 volumes, 3559 pages, 2558 illustrations

Eastman's Fundamentals of Vacuum Tubes, 2nd edition

Terman's Radio Engineering, 2nd edition

Everitt's Communication Engineering, 2nd edition

Hund's High Frequency Measurements

Henney's Radio Engineering Handbook, 3rd edition

Special Low Price, Easy Terms

Special price under this offer less than cost of books bought separately. In addition, you have the privilege of paying in easy installments beginning with \$3.00 in 10 days after receipt of books, and \$3.00 monthly thereafter. Already these books are recognized as standard works that you are bound to require sooner or later. Take advantage of these convenient terms to add them to your library now.

FOR 10 DAYS' EXAMINATION SEND THIS

---ON-APPROVAL COUPON---

McGraw-Hill Book Co., 330 W. 42 St., N. Y.
Send me Radio Engineering Library for 10 days' examination on approval. In 10 days I will send \$3.00 plus few cents postage, and \$3.00 monthly till \$24 is paid, or return books postpaid. (We pay postage on orders accompanied by remittance of first installment.)

Name

Address

City and State

Position

Company RR-4-42

War Cartoons in New Philco Ad Series

To appear in the May issues of leading national magazines is the first of a series of unusual ads, launched by Philco Corp. to tell the public of its war effort. The ads will feature cartoons drawn by some of the nation's most important artists, and will be concerned with America's victory effort.

Ernest B. Loveman, Philco's advertising manager, says that "the purpose of the new campaign is to convert our advertising, just as our plant facilities have been converted." In choosing the cartoon style, Philco recognizes the key part that humor and satire play in molding and expressing public opinion.

Don Lee-RCA Television Patent Interchange

A television patent interchange agreement has been made between the Don Lee Broadcasting system and the Radio Corporation of America, it has been announced by Thomas S. Lee, president of the Don Lee organization. Negotiations had started in 1939.

The Don Lee patents cover the inventions of Harry R. Lubcke, director of television of that firm, and are concerned with numerous phases of television, including synchronization, scanning, cathode-ray tubes, and the transmission of motion pictures as well as living subjects by television. The patents cover methods and apparatus for both transmission and reception.

GE Major Returns to Army

Major Boyd W. Bullock, advertising manager of General Electric's appliance and merchandise department, Bridgeport, Conn., has gone into active army service. He has reported at the Infantry School, Ft. Benning, Ga., where he will attend the Battalion Commands and Staff Officers Refresher Course, after which he will receive a permanent assignment.

Glenn Gundell, who has been assistant to the advertising manager, will be in charge during Major Bullock's absence.

NEMA's Spring Meeting

The Spring meeting of the National Electrical Manufacturers Association has been scheduled for May 11 to 14, at The Homestead, Hot Springs, Va. An extra heavy program of group meetings for NEMA members has been planned, in order to deal with the many wartime problems facing the industry.

Hodges & Glomb for Ken-Rad

The Ken-Rad Tube & Lamp Corp., Owensboro, has named Hodges & Glomb, 1264 Folsom St., San Francisco, Calif. as agents for radio tubes and lamps in the northern California territory.

Replacement
AUTO ANTENNAS

*The Big Idea
of the Season!*

• Yes, we have an idea that there's going to be a terrific yell for AUTO ANTENNA replacements this season. We offer jobbers our full co-operation, especially . . .

• IMMEDIATE DELIVERIES ★ LIFETIME GUARANTEE AGAINST RUSTING.

Better send at once for our COMPLETE 8-PAGE AUTO ANTENNA CATALOG.

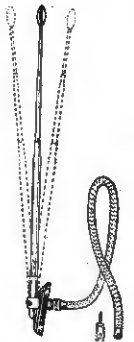

MODEL No. 4541 ICA "ROCKER" AERIAL, a Variable Angle Antenna to Fit the Contours of All Car Bodies.



NEW ENLARGED FACILITIES FOR MANUFACTURING ANTENNAS USED FOR DEFENSE AND OTHER ITEMS. Engineers: Send sketches for estimates.

INSULINE CORP. OF AMERICA
30-30 NORTHERN BLVD
LONG ISLAND CITY, N. Y.

*Where
to Buy*

For a complete directory of all radio-electronic products, see the March, 1942, issue of



Containing the 6th Annual edition of the

**RADIO YEAR BOOK
& TRADE DIRECTORY**

Radio's only directory having a complete listing of sources of supply for both Manufacturing and Distribution

■
CALDWELL-CLEMENTS, INC.
480 LEXINGTON AVENUE
NEW YORK

**SOMETHING'S MISSING
FROM 6 OUT OF 10 CARS**



GO OUT of Your Store to Sell *Motorola* **AUTO RADIO**

There's profitable business for you this year Mr. Dealer but it's business with a **difference**. Last year and the year before your customers walked into your store, took merchandise away from you and plunked down the cash. This year you'll have to do some telephoning . . . some post card writing, some car-spotting in parking lots, on boulevards, in garages, etc. The business is there **BUT YOU'LL HAVE TO GO OUTSIDE YOUR STORE TO GET IT!**



Use The Telephone

Ask the *Motorola* Salesman about his new **PROFIT PLANS**

Your Motorola salesman has a "how-to-do-it" book entitled "Something's Missing From That Car of Yours." There is a tested plan for a small dealer, a middle sized dealer, a big dealer. There is a tested plan for **small town** dealers, **small city** dealers and **metropolitan** dealers. The Motorola salesman will help you find the plan that will fit **your situation** perfectly! Don't sit or stand behind your counter chewing your nails waiting for the crack of doom. In a world at war Auto Radio is a necessity and of the 34 million cars and trucks on the road 22 million have no radio! Get busy right now . . . for quick sales and big profits.



Use The Mail

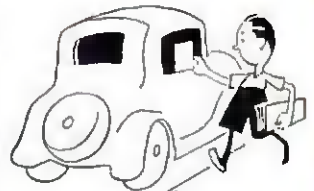

Spot The Cars

Write or Phone Your Motorola Distributor Today

GALVIN MFG. CORPORATION • CHICAGO, ILL.



RADIO: SPEARHEAD OF VICTORY!

COMMUNICATION, swift and certain—to coordinate every unit in action—is the first requirement of modern “lightning” warfare. Radio is keyed to the demands of such communication. And, fortunately, America has the greatest radio equipment in the world . . . thanks to research and engineering.

R.C.A. Communications, Inc., transmits and receives messages regularly and reliably to and from more than 45 foreign countries. Equally efficient is the ship-to-shore service of Radiomarine Corporation of America. In the plants of RCA Manufacturing Company, radio equipment for military purposes is coming off the production-

lines in volume—equipment that could not have been constructed in *any* quantity only a few short years ago! Through the National Broadcasting Company and the Blue Network, radio serves on still another front—keeping Americans unified and informed, through 55 million radio receivers!

On the overseas front, NBC operates two powerful short-wave stations—WRCA and WNBI at Bound Brook, N. J. They help to hurl America’s answer in the “war of words.” Their short-wave beams carrying authentic news, are spearheads of truth through the darkness of war. Today freedom rides America’s radio beams to all the world.



RADIO CORPORATION OF AMERICA

Radio City, New York

The Services of RCA:

RCA Manufacturing Co., Inc. • R.C.A. Communications, Inc. • Radiomarine Corporation of America
RCA Laboratories • National Broadcasting Co., Inc. • Blue Network Co., Inc. • RCA Institutes, Inc.

www.americanradiohistory.com